

**Want More?
Solutions Start
Here!**



**Comprehensive
Treatment**

**Enhanced
Knowledge**

**Business
Excellence**

Introducing **BIOMET 3i**'s Product Catalog For Surgical Technologies

The Solution Designed To Provide Clinicians With Surgical Options:

- Patient Driven Implant Systems
- Comprehensive Line Of Site-Specific Regenerative Options
- Business Excellence Solutions To Help Grow Your Practice



Providing Solutions – One Patient At A Time™

- Tapered And Parallel Walled Implants Designed To Support A Wider Range Of Treatment Options
- Site Preparation Products Designed To Assist With Accurate Placement
- Regenerative Products Designed For Bone And Soft Tissue Growth

BIOMET 3i™
PROVIDING SOLUTIONS – ONE PATIENT AT A TIME™

Instructions For Use

This document applies to dental implants, abutments, overdenture bars and associated surgical, restorative and dental laboratory components.

Description: BIOMET 3i Dental Implants are manufactured from biocompatible titanium and titanium alloy and abutments from titanium, titanium alloy, gold alloy and ceramic material. BIOMET 3i Dental Implants and Abutments include various surface treatments and coatings. Other restorative components are manufactured with titanium, titanium alloy, gold alloy, stainless steel and a variety of polymers.

For specific product description and net quantity refer to individual product labels.

Indications for Use: BIOMET 3i Dental Implants are intended for surgical placement in the upper or lower jaw to provide a means for prosthetic attachment in single tooth restorations and in partially or fully edentulous spans with multiple single teeth utilizing delayed or immediate loading, or as a terminal or intermediary abutment for fixed or removable bridgework, and to retain overdentures.

BIOMET 3i OSSEOTITE® and NanoTite™ Dental Implants are intended for immediate function on single tooth and/or multiple tooth applications when good primary stability is achieved, with appropriate occlusal loading, in order to restore chewing function.

Additional Indications: BIOMET 3i Dental Abutments and Overdenture Bars are intended for use as an accessory to endosseous dental implants to support a prosthetic device in a partially or edentulous patient. These are intended for use to support single and multiple tooth prostheses, in the mandible or maxilla. The prostheses can be screw or cement retained to the abutment.

PEEK Abutment Posts and Temporary Cylinders are intended for use as an accessory to endosseous dental implants to support a prosthetic device in a partially or fully edentulous patient. These are intended for use to support single and multiple unit prostheses in the mandible or maxilla for up to 180 days during endosseous and gingival healing, and are for non-occlusal loading of single and multiple unit provisional restorations. The prostheses can be screw and/or cement-retained to the abutment. These Temporary Posts and Cylinders require a minimum interarch space of 6mm and a maximum angulation of 15°. These also allow for occlusal loading of single and multiple unit restorations of integrated implants for guided soft tissue healing.

The QuickBridge® Provisional Components are intended to be mated with BIOMET 3i Conical Abutments for use as an accessory to endosseous dental implants to support a prosthetic device in a partially or fully edentulous patient. The QuickBridge Provisional Components are intended to support multiple unit prostheses in the mandible or maxilla for up to 180 days during endosseous and gingival healing.

Contraindications: Placement of dental implants may be precluded by patient conditions that are contraindications for surgery. BIOMET 3i Dental Implants should not be placed in patients where the remaining jaw bone is too diminished to provide adequate implant stability.

Storage and Handling: Devices should be stored at room temperature. Refer to individual product labels and the Surgical Manual for special storage or handling conditions.

Warnings: Excessive bone loss or breakage of a dental implant or restorative device may occur when an implant or abutment is loaded beyond its functional capability. Physiological and anatomic conditions may negatively affect the performance of dental implants. The following should be taken into consideration when placing dental implants:

- Poor bone quality
- Poor oral hygiene
- Medical conditions such as blood disorders or uncontrolled hormonal conditions

It is recommended that small diameter implants not be restored with angled abutments in the molar region.

Mishandling of small components inside the patients mouth carries a risk of aspiration and/or swallowing.

Forcing the implant into the osteotomy deeper than the depth established by the drills can result in: stripping the driver hex interface inside the implant, stripping the driver, cold-welding of the mount-driver interface to the implant, or stripping the walls of the osteotomy that may prevent an effective initial implant fixation.

Clinical data have demonstrated enhanced performance of OSSEOTITE Implants as compared to other BIOMET 3i Dental Implants in patients with poor quality bone.

Precautions: For safe and effective use of BIOMET 3i Dental Implants, abutments and other surgical and restorative dental accessories, these products or devices should only be used by trained professionals. The surgical and restorative techniques required to properly utilize these devices are highly specialized and complex procedures. Improper technique can lead to implant failure, loss of supporting bone, restoration fracture, screw loosening and aspiration.

Sterility: All dental implants and some abutments are supplied sterile and are sterilized by an appropriate validated method. Refer to individual product labels for sterilization information; all sterile products are labeled 'STERILE.' All products sold sterile are for single use before the expiration date printed on the product label. Do not use sterile products if the packaging has been damaged or previously opened. Do not re-sterilize or autoclave except where instructions to do so are provided on the product label, in the Surgical Manual, in the Restorative Manual or in any additional marketing literature for that product. Products provided non-sterile must be cleaned and sterilized according to the directions found in ART630 or the Surgical Manual prior to use.

Procedural Precautions, Surgery: For a detailed explanation of the procedural precautions refer to the Surgical Manual. During the planning phase, it is important to determine the vertical dimension, the actual space available between the alveolar crest and the opposing dentition, in order to confirm that the available space will accommodate the proposed abutment and the final crown restoration. This information varies with each patient and abutment; therefore it should be carefully evaluated before placing any dental implant. The final prosthesis should be designed prior to the placement of the dental implant. Utilize continuous irrigation with a cool, sterile irrigating solution to avoid excessive damage to the surrounding tissue and to prevent compromising osseointegration. This is mandatory during all procedures. Avoid excessive pressure during preparation of the bone site. As the drilling speed varies based on the instrument and the surgical procedure, recommendations for speed can be found in the Surgical Manual. Only sharp instruments of the highest quality should be used for any surgical procedure involving bone. Minimizing trauma to the bone and surrounding tissue enhances the potential for successful osseointegration. In order to eliminate contaminants and other sources of infection, all non-sterile devices should be cleaned and/or sterilized prior to use, per the instructions on the individual product labels.

Procedural Precautions, Restoration: The healing period varies depending on the quality of the bone at the implantation site, the tissue response to the implanted device and the surgeon's evaluation of the patient's bone density at the time of the surgical procedure. Excessive force applied to the dental implant should be avoided during the healing period. Proper occlusion should be evaluated on the implant restoration to avoid excessive force.

Potential Adverse Events: Potential adverse events associated with the use of dental implants may include:

- Failure to integrate
- Loss of integration
- Dehiscence requiring bone grafting
- Perforation of the maxillary sinus, inferior border, lingual plate, labial plate, inferior alveolar canal, gingiva
- Infection as reported by: abscess, fistula, suppuration, inflammation, radiolucency
- Persistent pain, numbness, paresthesia
- Hyperplasia
- Excessive bone loss requiring intervention
- Implant breakage or fracture
- Systemic infection
- Nerve injury

Caution: U.S. Federal Law restricts this device to sale by or on the order of a licensed dentist or physician.

Table Of Contents

Introduction

Company Overview	i
Product Innovations Timeline	ii
Surface Technologies	
The NanoTite™ Implant Family	iii
The OSSEOTITE® Implant Family	iv
System Distinctions	
Certain® Internal Connection Implants	v
External Hex Connection Implants	vi
Implant Configurations	vii
Top Down Treatment Planning	xii

Implants

Certain® Internal Connection:

NanoTite Certain PREVAIL®	1
OSSEOTITE Certain PREVAIL	1
NanoTite Tapered Certain PREVAIL	2
NanoTite Parallel Walled Certain	2
OSSEOTITE Parallel Walled Certain	3
OSSEOTITE XP® Certain	3
Full OSSEOTITE Parallel Walled Certain	3
Full OSSEOTITE XP Certain	3
NanoTite Tapered Certain	4
OSSEOTITE Tapered Certain	4
Full OSSEOTITE Tapered Certain	4

External Hex Connection:

NanoTite Parallel Walled	5
OSSEOTITE Parallel Walled	6
OSSEOTITE XP	6
Full OSSEOTITE Parallel Walled	6
Full OSSEOTITE XP	6
NanoTite Tapered	7
OSSEOTITE Tapered	8
Full OSSEOTITE Tapered	8

Healing Abutments

Certain Internal Connection:

Encode®	9
EP®	11

External Hex Connection:

Encode	13
EP	15

Site Preparation Technologies

Site Preparation Product Overview	19
DU900 Surgical Drilling Unit	21
OSSEOCISION® Surgical Drilling Unit	22
Disposable Single-Patient-Use Drill Kits	23
Navigator® System Surgical Kit	25
Navigator System Laboratory Kit	27
Tapered Implant Surgical Kits	28
Parallel Walled Surgical Kits	31
Reusable Twist Drills, Disposable Twist Drills	35
Surgical Drills	36
Surgical Components	37
Site Preparation Technologies	
Straight, Angled And Summer Osteotomes	45
Sinus Elevation, Trephine Burs	46

Regenerative Technologies

Regenerative Technologies Product Overview	47
Allografts	
RegenerOss® Allograft	49
RegenerOss Allograft Putty	50
Xenografts	
Endobon® Xenograft Granules	50
GBR Barrier	
OsseoGuard® Membrane	50
Alloplasts	
Biogran®, Calcigen™ Oral	50
Autogenous	
Safescraper® TWIST, R. Quéting Bone-Mill	50

Professional Development Products

Tools For The Art Of Business Building	51
--	----

Additional Information

Index	52
Ordering Form	
Ordering Information	

Introduction

Company Overview

BIOMET 3i™ Providing Solutions – One Patient At A Time™

Mission Statement:

BIOMET 3i will be recognized as a global leader in the oral reconstruction marketplace. We will achieve this through superior customer support and continuous product innovation.

BIOMET 3i offers one of implant dentistry's most comprehensive lines of implants and abutments, augmented by a growing line of site preparation and regenerative products. BIOMET 3i pioneered the development of biologically driven implants, winning worldwide acclaim for the microtextured surface and superior clinical success rates of the OSSEOTITE® Implant.

Headquartered in Palm Beach Gardens, Florida, with operations throughout the world, BIOMET 3i is one of the leading companies in the oral reconstruction market. Of equal importance, BIOMET 3i brings the same innovation, high standards and comprehensive approach to customer service, practice and laboratory support and education.

Our Solutions Offer:

Comprehensive Treatment

- Patient Driven Implant Systems
- End-To-End Prosthetic Solutions
- Site-Specific Regenerative Options

Enhanced Knowledge

- Comprehensive Educational Continuum For All Levels Of Expertise
- Diversified Delivery Options
- Audience-Specific Program Options

Business Excellence

- Patient Recruitment Support
- Business Efficiency Support
- Practice Growth Support

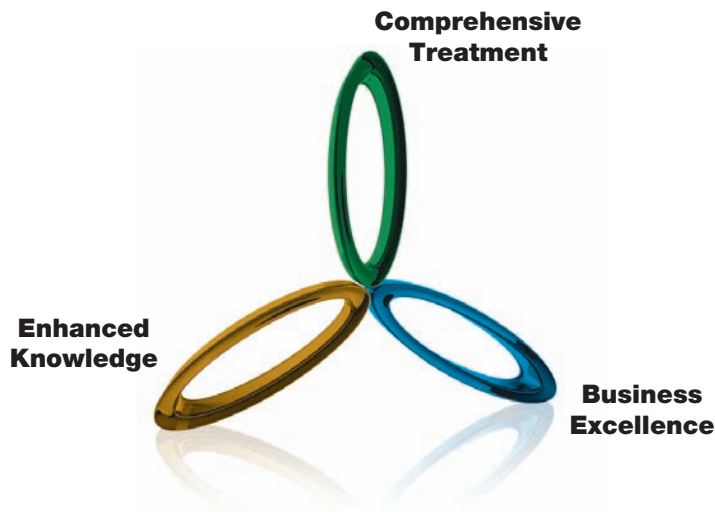

Introduction



Product Innovations Timeline - 1987 To Present

1987	1988	1989	1990
<ul style="list-style-type: none"> • 2mm Standard Abutments • One-Piece Abutment Posts 	<ul style="list-style-type: none"> • Machined Gold UCLA Abutments • Modification Abutments • 2.9mm Miniplants® • Pre-Angled Abutments 	<ul style="list-style-type: none"> • Tapered Abutments • 3.75mm Threaded Implants 	<ul style="list-style-type: none"> • EP® Healing Abutments
1991	1992	1993	1994
<ul style="list-style-type: none"> • Wide Diameter Implants 	<ul style="list-style-type: none"> • Conical Abutments For Single-Unit Applications 	<ul style="list-style-type: none"> • Protocol For Single-Stage Surgery With Hex Top Implants • Two-Piece EP Healing Abutments • Two-Piece Abutment Posts 	<ul style="list-style-type: none"> • Emergence Profile System • EP Abutment Posts • STA® Abutments
1995	1996	1997	1998
<ul style="list-style-type: none"> • ASYST Abutment Delivery System • Twist Lock™ Impression Copings • ICET™ Implants 	<ul style="list-style-type: none"> • OSSEOTITE® Implants • Gold Standard ZR™ Hex Machining 	<ul style="list-style-type: none"> • TG OSSEOTITE® Single-Stage Implants 	<ul style="list-style-type: none"> • Prep-Tite® Posts • Gold-Tite® Screws • Biogran® Bone Graft Material
1999	2000	2002	2003
<ul style="list-style-type: none"> • GingiHue® Posts • 15° Pre-Angled GingiHue Posts • Prep-Tite Caps • Try-In Screw With One Turn • OSSEOTITE XP® Implants • Restorative Torque Indicator 	<ul style="list-style-type: none"> • ZiReal® Posts • Simple Logic™ • PCCS® Platelet Concentrate Collection System 	<ul style="list-style-type: none"> • LOCATOR® Abutments • Safescraper® Bone Collector • Tapered Implant System • Calcigen™ Oral Bone Graft Stabilizer 	<ul style="list-style-type: none"> • OSSEOTITE Certain® Internal Connection Implant System With The QuickSeat® Connection • OverdentSURE Approach
2004	2005	2006	2007
<ul style="list-style-type: none"> • DIEM® Immediate Occlusal Loading Guidelines & IOL® Components • ARCHITECH PSR®: CAM StructSURE® Precision Milled Bars, Encode® Restorative System 	<ul style="list-style-type: none"> • 3i IDS Learning Library® • PREVAIL® Implants • Provide® Abutments 	<ul style="list-style-type: none"> • Advanced Cutting Technology® (ACT™) Twist Drills • OSSEOCISION® Drilling Unit • PreFormance® Provisional Components 	<ul style="list-style-type: none"> • NanoTite™ Implants • Conical Angled Abutments • QuickBridge® Provisional Components • OsseoGuard® Membrane
2008	2009	2010	
<ul style="list-style-type: none"> • Navigator® System For CT Guided Surgery • NanoTite Tapered PREVAIL Implants • Encode Complete • RegenerOss® Family Of Products 	<ul style="list-style-type: none"> • Low Torque Indicating Ratchet Wrench 	<ul style="list-style-type: none"> • Larger Particle Size Endobon® Xenograft Granules • Low Profile Abutments 	

Introduction

Surface Technologies

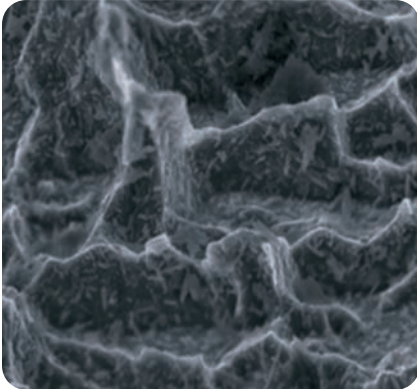

NanoTite Surface at 20,000x magnification

The NanoTite™ Implant Family

The NanoTite Implant represents BIOMET 3i's most recent advanced dental implant surface technology since the introduction of the OSSEOTITE® Implant in 1996. The NanoTite Implant is the patented OSSEOTITE Dual-acid-etched Surface, which is then further treated with a deposition of nanometer scale crystals of calcium phosphate. This is known as the Discrete Crystalline Deposition Process or DCD Process. The surface treatment is a discrete crystalline deposition on the OSSEOTITE Surface, not a plasma sprayed coating.

The synergistic effect of these two technologies, the OSSEOTITE Surface and DCD Process, has demonstrated promising results in animal studies. Because of this synergistic effect, a more complex micro-surface is created. Preclinical studies demonstrated that the NanoTite Surface treatment, when compared to OSSEOTITE Control Implants, significantly improves the rate and extent of bone to implant contact and results in statistically significant enhanced integration.

For all NanoTite Configurations, wherever there is the dual-acid-etched OSSEOTITE Surface, the DCD Nano-scale Calcium Phosphate has been applied.

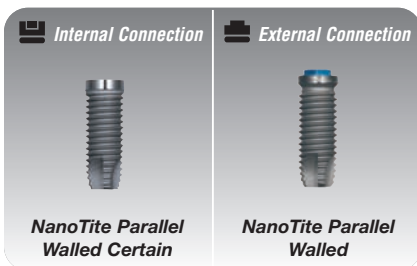
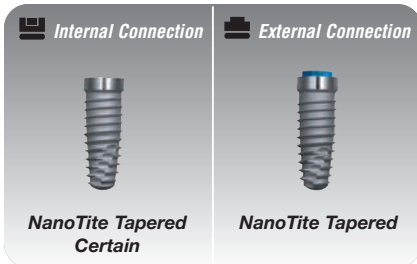
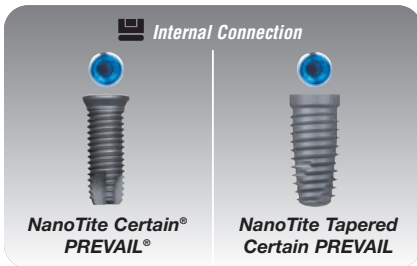

Introduction

Surface Technologies

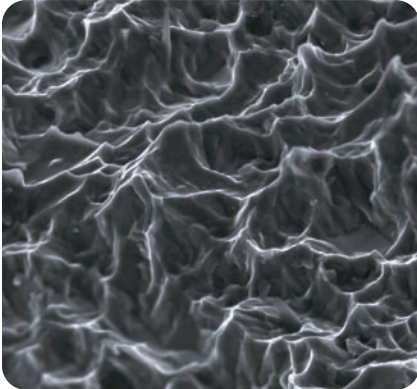

OSSEOTITE Surface at 20,000x magnification

The OSSEOTITE® Implant Family

The OSSEOTITE Implant features our patented acid-etched surface that is optimal for: Improving the clot/implant attachment which may increase platelet activation and red blood cell (rbc) agglomeration.

For more than 10 years, with documentation from numerous global multicenter clinical evaluations, the OSSEOTITE Surface has proven to be one of the most predictable and well-researched surfaces ever*. Clinical studies on the OSSEOTITE Surface continue to document the benefits of increased Contact Osteogenesis, especially in poor-quality bone.

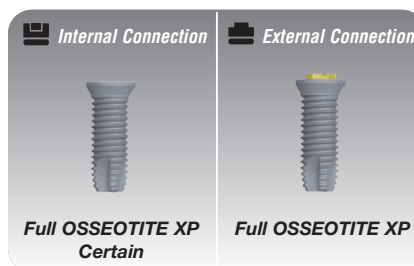
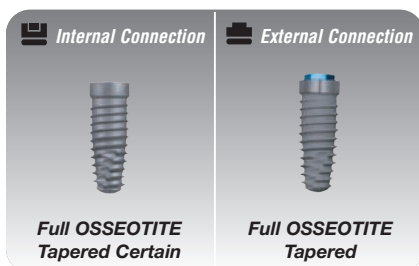
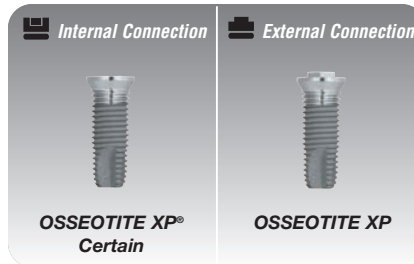
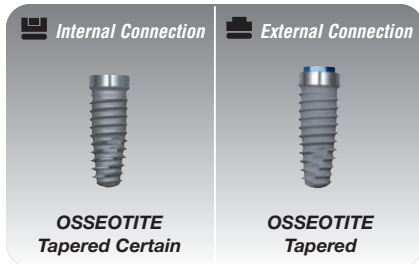
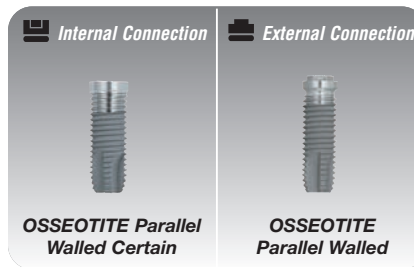

*Data on file.

Introduction

System Distinctions

Certain® Internal Connection Implants

The internal connection implant design is for ease of use and simplicity.

Material: Titanium Alloy

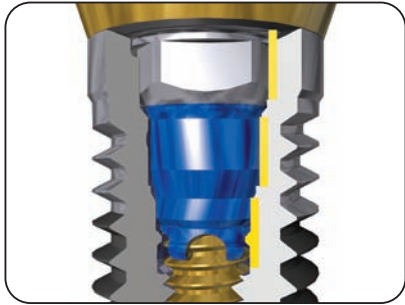

- **QuickSeat® Connection: It Clicks!** The Certain Implant System features the QuickSeat Connection, which has an audible and tactile “click” when placing impression copings and abutments. This click feedback provides confirmation and confidence to a clinician that the components are properly seated. *When It Clicks, It's Seated. You're Certain.*

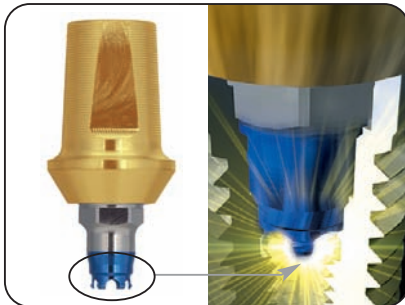

- Abutment fingers cause the “click” and also provide retention for the prosthetic components in the implant when restorations are being tried in or placed before the screw is placed.

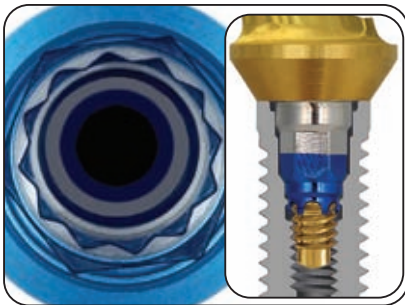

- The 6/12 internal connection has both a hex and a 12-point double hex. The hex has two functions: engaging the driver tip for mountless delivery during implant placement and providing anti-rotation for all straight abutments. The 12-point double hex provides rotational positioning every 30° for pre-angled abutments.



- **Impression Copings: Pick-Up and Twist Lock™ Transfer Copings** are available in the internal connection design. The impression copings also “click” when properly seated. The copings have a different finger design that engages 2mm internally in the implant, as compared to the abutment's design that engages 4mm deep in the implant. This shorter engagement in the implant is important because it allows off-axis draw for impressions of divergent implants.

Introduction

System Distinctions

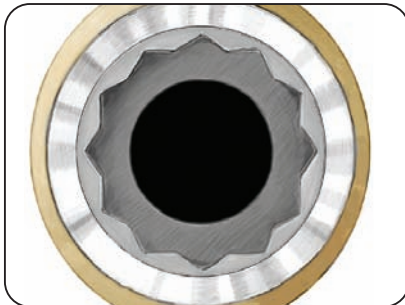
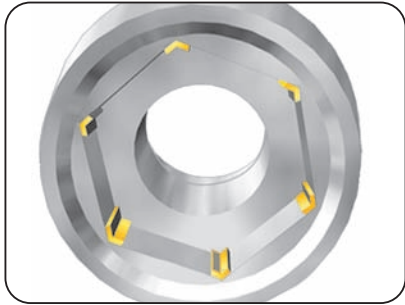

External Hex Connection Implants

The external hexed implant design is widely used offering versatility and restorative flexibility.

Material: Commercially Pure Titanium (OSSEOTITE® Implants)
Titanium Alloy (NanoTite™ Implants)

- Gold Standard ZR™ (Zero Rotation) is a patented design of machined microstops within the corners of the hex in the abutment. The design reduces horizontal rotation between the implant and abutment. Gold Standard ZR is available on UCLA, GingiHue® Post and Conical Abutments.
- The 12-point double hex, which is machined in the 15° Pre-Angled GingiHue Post, provides rotational positioning in 30° increments on the implant hex.
- Impression Copings: Pick-Up and Twist Lock™ Transfer Copings are both available in the external hex design and three EP® (Emergence Profile) Diameters. The patented Twist Lock Design provides a more accurate transfer of the implant hex compared to other transfer (closed tray) techniques. The unique Twist Lock Feature provides a series of undercuts to guide the coping into the impression for stability. As a result, the copings lock into orientation grooves upon clockwise rotation, thereby allowing a tactile sensation of resistance that ensures an accurate hex transfer.
- Precise Abutment Placement: The Asyst Abutment Placement Tool provides fingertip control for fast and easy abutment delivery. The patented packaging design makes abutment placement easier because the abutment is delivered sterile from the package directly to the implant site. The system includes the abutment, abutment screw and plastic seating device. The plastic seating device facilitates precise placement of the abutment on the implant, thus reducing chair time. The Asyst Tool is packaged with the Standard and Conical Abutments.

Introduction

Implant Configurations

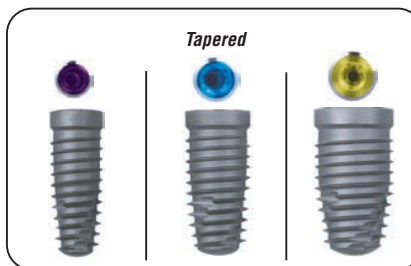
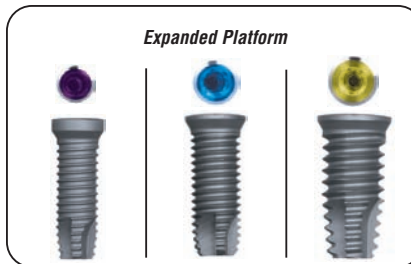
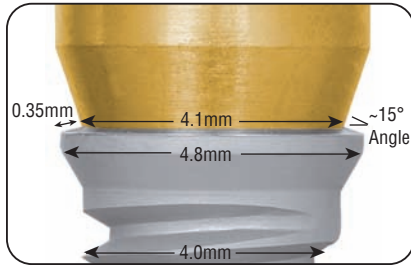
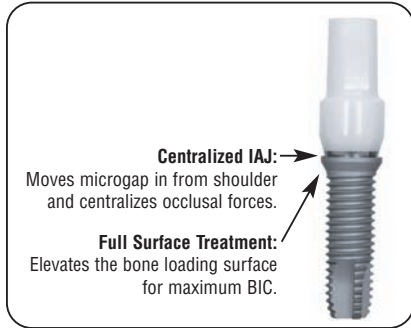

Certain® PREVAIL® Platform Switching Implants

BIOMET **3i** has created an implant system that is designed to help clinicians in the pursuit of crestal bone preservation. The Certain PREVAIL Implant features Integrated Platform Switching, which incorporates a coronal bevel design that medializes the Implant Abutment Junction (IAJ). This feature is available with both OSSEOTITE® and NanoTite™ Implants unless otherwise noted.

The Certain PREVAIL Implant's prosthetic table is appropriately color-coded to ensure proper matching of the corresponding BIOMET **3i** Abutments.

The Certain PREVAIL Implant offers the Certain QuickSeat® Connection. This provides the clinician with an audible and tactile click that confirms the abutment is properly seated. The double hex allows as many as 12 rotational positions, which is ideal for angled abutments.

The Certain PREVAIL Implant includes several significant features. The surface on both the OSSEOTITE and NanoTite Implant extends to the top of the collar where the medialization of the implant begins, creating a continuous bone loading surface.

The Certain PREVAIL Platform Switching Implant is offered in three different implant configurations:

Certain PREVAIL Expanded Platform Implant

The expanded platform allows the coronal aspect of the implant to lock in to the crestal region.

Certain PREVAIL Straight Collar Implant

May be beneficial in clinical situations where the expanded collar is not ideal. The straight collar design provides the option to use the PREVAIL Implant in narrower interdental spaces or in cases with limited ridge widths.

NanoTite Tapered PREVAIL Implant

Incorporates all of the design features of a platform switching implant with a tapered design, which approximates the shape of a natural tooth root. The innovative thread angle, depth and pitch produces an anchoring "bite on bone" response for establishing primary stability.

Introduction

Implant Configurations

Icon Descriptions:

The following icons are used to represent the connection type of the implant system:

 Internal  External

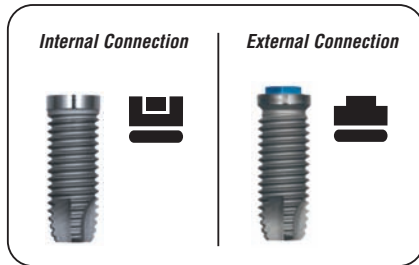

Certain® Internal Connection Implants And External Hex Connection Parallel Walled Implants

These implants feature the unique ICE™ Self-Tapping Design, are available in both NanoTite™ and OSSEOTITE® Surface configurations and in Certain Internal Connection and external hex connection implant configurations.

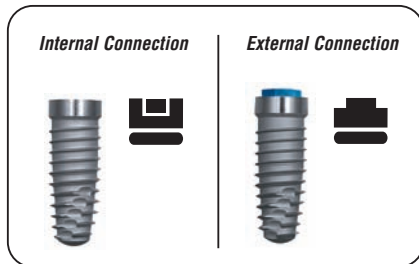

Certain Internal Connection Tapered Implants And External Hex Connection Tapered Implants

These implants closely approximate the shape of a natural tooth root with a thread design that produces an anchoring “bite in bone” response. These are available in both NanoTite and OSSEOTITE Surface configurations and in Certain Internal Connection and external hex connection implant configurations.

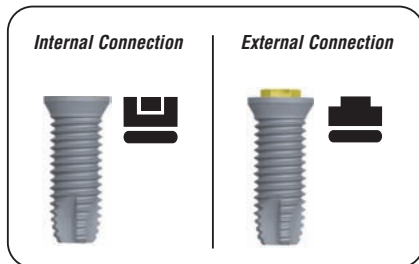

OSSEOTITE XP® Expanded Platform Implants

The OSSEOTITE XP Expanded Platform Implant has a flared coronal aspect that engages and locks into the bone crest, while the wider prosthetic platform allows for optimal Emergence Profile. The narrower implant body fits in areas where bone volume may be limited.

Introduction

Implant Configurations

		Product Code	Length (mm)	Diameter/Max. Diam (mm)	Seating Surface (mm)	Apical Diameter (mm)	Surface Height (mm)	Surface Height	Thread Pitch (mm)
NanoTite™ Certain® PREVAIL® Implants	NanoTite Certain PREVAIL (straight collar)	NIOSxxxx	8.5, 10, 11.5, 13, 15	4.0/4.1 5.0/5.0	3.4 4.1	2.6 3.1	8.03, 9.53, 11.02, 12.52, 14.53	Top Of Implant Collar	NIOS43xx = 0.6 NIOS54xx = 0.9
	NanoTite Certain PREVAIL (expanded platform)	NIOSxxxx	8.5, 10, 11.5, 13, 15	3.25/4.1 4.0/4.8 5.0/5.8	3.4 4.1 5.0	2.4 2.6 3.1	8.03, 9.53, 11.02, 12.52, 14.53	Top Of Implant Collar	NIOS34xx and NIOS45xx = 0.6 NIOS56xx = 0.9
	NanoTite Tapered PREVAIL	NIITPxxxx	8.5, 10, 11.5, 13, 15	4.0 5.0 6.0	3.4 4.1 5.0	2.4 3.2 3.9	8.00, 9.50, 11.00, 12.50, 14.50	Top Of Implant Collar	0.8
NanoTite Certain Implants	NanoTite Certain 3.25mm	NIOSMxxx	8.5, 10, 11.5, 13, 15, 18	3.25	3.4	2.4	6.99, 8.48, 9.98, 11.48, 13.49, 16.51	Base Of Collar	0.6
	NanoTite Certain	NIOSxxx	8.5, 10, 11.5, 13, 15, 18 ¹	4.0 5.0 6.0	4.1 5.0 6.0	2.6 3.1 4.1	NIOS4xx = 6.99, 8.48, 9.98, 11.48, 13.49, 16.51 NIOS5xx/6xx = 6.86, 8.36, 9.86, 11.35, 13.36	Base Of Collar	NIOS4xx = 0.6 NIOS5xx and NIOS6xx = 0.9
	NanoTite Tapered Certain	NINTx(x)xx	8.5, 10, 11.5, 13, 15	3.25, 4.0, 5.0, 6.0	3.4, 4.1, 5.0, 6.0	1.9, 2.4, 3.2, 3.9	6.86, 8.36, 9.86, 11.35, 13.36	Base Of Collar	0.8
NanoTite External Hex Connection Implants	NanoTite 3.25mm	NOSMxxx	8.5, 10, 11.5, 13, 15, 18	3.25	3.4	2.4	6.99, 8.48, 9.98, 11.48, 13.49, 16.48	Base Of Collar	0.6
	NanoTite	NOSSxxx	7, 8.5, 10, 11.5, 13, 15, 18	4.0 5.0 6.0	4.1 5.0 6.0	2.6 3.1 4.1	NOSS4xx = 5.84, 7.37, 8.86, 10.36, 11.86, 13.87, 16.87 NOSS5xx/6xx = 6.15, 7.67, 9.17, 10.67, 12.17, 14.17, 17.17	Base Of Collar	NOSS4xx = 0.6 NOSS5xx and NOSS6xx = 0.9
	NanoTite Tapered	NNTx(x)xx	8.5, 10, 11.5, 13, 15	3.25, 4.0, 5.0, 6.0	3.4, 4.1, 5.0, 6.0	1.9, 2.4, 3.2, 3.9	6.86, 8.36, 9.86, 11.35, 13.36	Base Of Collar	0.8

¹ 18mm length only available in 4xx

Introduction

Implant Configurations

		Product Code	Length (mm)	Diameter/Max. Diam (mm)	Seating Surface (mm)	Apical Diameter (mm)	Surface Height (mm)	Surface Height	Thread Pitch (mm)
Full OSSEOTITE® Certain® Implants	Full OSSEOTITE Certain 3.25mm	IFOSMxxx	8.5, 10, 11.5, 13, 15	3.25	3.4	2.4	8.13, 9.63, 11.13, 12.62, 14.63	Top Of Implant Collar	0.6
	Full OSSEOTITE Certain	IFOSxxxx	8.5, 10, 11.5, 13, 15	4.0 5.0 6.0	4.1 5.0 6.0	2.6 3.1 4.1	8.13, 9.63, 11.13, 12.62, 14.63	Top Of Implant Collar	IFOS4xx = 0.6 IFOS5xx and IFOS6xx = 0.9
	Full OSSEOTITE XP® Certain	IFOSxxxx	8.5, 10, 11.5, 13, 15	4.0/5.0 5.0/6.0	5.0 6.0	2.6 3.1	8.13, 9.63, 11.13, 12.62, 14.63	Top Of Implant Collar	IFOS45xx = 0.6 IFOS56xx = 0.9
	Full OSSEOTITE Tapered Certain	IFNTx(x)xx	8.5, 10, 11.5, 13, 15	3.25, 4.0, 5.0, 6.0	3.4, 4.1, 5.0, 6.0	1.9, 2.4, 3.2, 3.9	8.13, 9.63, 11.13, 12.62, 14.63	Top Of Implant Collar	0.8
Full OSSEOTITE External Hex Connection Implants	Full OSSEOTITE 3.25mm	FOSMxxx	7, 8.5, 10, 11.5, 13, 15	3.25	3.4	2.4	6.38, 8.13, 9.63, 11.13, 12.62, 14.63	Top Of Implant Collar	0.6
	Full OSSEOTITE	FOSxxx	7, 8.5, 10, 11.5, 13, 15	3.75, 4.0, 5.0, 6.0	4.1, 4.1, 5.0, 6.0	2.3, 2.6, 3.1, 4.1	6.60, 8.13, 9.63, 11.13, 12.62, 14.63	Top Of Implant Collar	FOS3xx and FOS4xx = 0.6 FOS5xx, and FOS6xx = 0.9
	Full OSSEOTITE XP	FOSxxxx	7, 8.5, 10, 11.5, 13, 15	3.25/4.1 4.0/5.0 5.0/6.0	4.1 5.0 6.0	2.4 2.6 3.1	6.60, 8.13, 9.63, 11.13, 12.62, 14.63	Top Of Implant Collar	FOS32xx and FOS45xx = 0.6 FOS56xx = 0.9
	Full OSSEOTITE Tapered	FNTx(x)xx	8.5, 10, 11.5, 13, 15	3.25, 4.0, 5.0, 6.0	3.4, 4.1, 5.0, 6.0	1.9, 2.4, 3.2, 3.9	8.13, 9.63, 11.13, 12.62, 14.63	Top Of Implant Collar	0.8
OSSEOTITE Certain PREVAIL® Implants	OSSEOTITE Certain PREVAIL (straight collar)	IIOSxxxx	8.5, 10, 11.5, 13, 15	4.0/4.1 5.0/5.0	3.4 4.1	2.6 3.1	8.03, 9.53, 11.02, 12.52, 14.53	Top Of Implant Collar	IIOS43xx = 0.6 IIOS54xx = 0.9
	OSSEOTITE Certain PREVAIL (expanded platform)	IIOSxxxx	8.5, 10, 11.5, 13, 15	3.25/4.1 4.0/4.8 5.0/5.8	3.4 4.1 5.0	2.4 2.6 3.1	IIOS34xx = 8.05, 9.55, 11.05, 12.55, 14.55 IIOS45xx/56xx = 8.03, 9.52, 11.02, 12.52, 14.53	Top Of Implant Collar	IIOS34xx and IIOS45xx = 0.6 IIOS56xx = 0.9

Introduction

Implant Configurations

		Product Code	Length (mm)	Diameter/Max. Diam (mm)	Seating Surface (mm)	Apical Diameter (mm)	Surface Height (mm)	Surface Height	Thread Pitch (mm)
OSSEOTITE® Certain® Implants	OSSEOTITE Certain 3.25mm	IOSMxxx	8.5, 10, 11.5, 13, 15, 18	3.25	3.4	2.4	6.35, 6.32, 7.82, 9.32, 11.33, 14.35	Third (3rd) Thread From Collar Base	0.6
	OSSEOTITE Certain	IOSSxxxx	8.5, 10, 11.5, 13, 15, 18 ² , 20 ²	4.0 5.0 6.0	4.1 5.0 6.0	2.6 3.1 4.1	IOSS4xx/6xx = 6.35, 6.32, 7.82, 9.32, 11.33, 14.35, 16.36 IOSS5xx = 6.35, 6.20, 7.70, 9.19, 11.20	Third (3rd) Thread From Collar Base	IOSS4xx = 0.6 IOSS5xx and IOS56xx = 0.9
	OSSEOTITE XP® Certain	IOSxxxx	8.5, 10, 11.5, 13, 15	4.0/5.0 5.0/6.0	5.0 6.0	2.6 3.1	IOS45xx = 6.35, 6.71, 8.20, 9.70, 11.71 IOS56xx = 6.35, 6.83, 8.33, 9.83, 11.84	Third (3rd) Thread From Collar Base	IOS45xx = 0.6 IOS56xx = 0.9
	OSSEOTITE Tapered Certain	INTx(x)xx	8.5, 10, 11.5, 13, 15	3.25 4.0 5.0 6.0	3.4 4.1 5.0 6.0	1.9 2.4 3.2 3.9	6.86, 8.36, 9.86, 11.35, 13.36	Base Of Collar	0.8
OSSEOTITE External Hex Connection Implant	OSSEOTITE 3.25mm	OSMxxx	8.5, 10, 11.5, 13, 15, 18	3.25	3.4	2.4	6.35, 5.69, 7.19, 8.69, 10.69, 13.69	Third (3rd) Thread From Collar Base	0.6
	OSSEOTITE	OSSxxx	7 ³ , 8.5, 10, 11.5, 13, 15, 18, 20 ⁴	3.75 4.0 5.0 6.0	4.1 4.1 5.0 6.0	2.3 2.6 3.1 4.1	4.83, 6.35, 5.69, 7.19, 8.69, 10.69, 13.69, 15.70	Third (3rd) Thread From Collar Base	OSS3xx and OSS4xx = 0.6 OSS5xx and OSS6xx = 0.9
	OSSEOTITE XP	OSxxxx	8.5, 10, 11.5, 13, 15, 18 ⁵	3.25/4.1 4.0/5.0 5.0/6.0	4.1 5.0 6.0	2.4 2.6 3.1	6.35, 6.32, 7.82, 9.32, 11.33, 14.33	Third (3rd) Thread From Collar Base	OS32xx and OS45xx = 0.6 OS56xx = 0.9
	OSSEOTITE Tapered	NTX(x)xx	8.5, 10, 11.5, 13, 15	3.25 4.0 5.0 6.0	3.4 4.1 5.0 6.0	1.9 2.4 3.2 3.9	6.86, 8.36, 9.86, 11.35, 13.36	Base Of Collar	0.8

- ² 18mm & 20mm lengths only available in 4xx
³ 7mm length only available in 5xx & 6xx
⁴ 20mm length only available in 3xx & 4xx
⁵ 18mm length only available in 3/4 only

Introduction

Top-Down Treatment Planning

In its simplest form, top-down treatment planning refers to a protocol whereby the desired restorative result is considered first, leading to consideration of the ideal prosthetic platform and subsequent implant selection based on bony anatomy.

A top-down treatment planning methodology will provide maximum biomechanical stability and allow for soft tissue flaring by utilizing an implant with a prosthetic platform slightly smaller in diameter than the emergence diameter of the tooth being replaced. BIOMET 3i's wide selection of implants allows clinicians to match the size of the prosthetic platform to the restoration it will eventually support, while allowing for different bone volumes and anatomical features

at the implant site. Implant and healing abutment selections are based upon the relationship of several key measurements:

- The emerging dimension of the crown in relation to the diameter of the prosthetic platform of the implant
- The height and diameter of the intended restoration at the tissue exit point
- The bone volume at the implant site in relation to the diameter of the implant body

The Emergence Profile (EP®) Healing Abutment System consists of healing abutments of various diameters and heights for shaping the soft tissue to replicate the geometry and gingival contours of natural dentition.

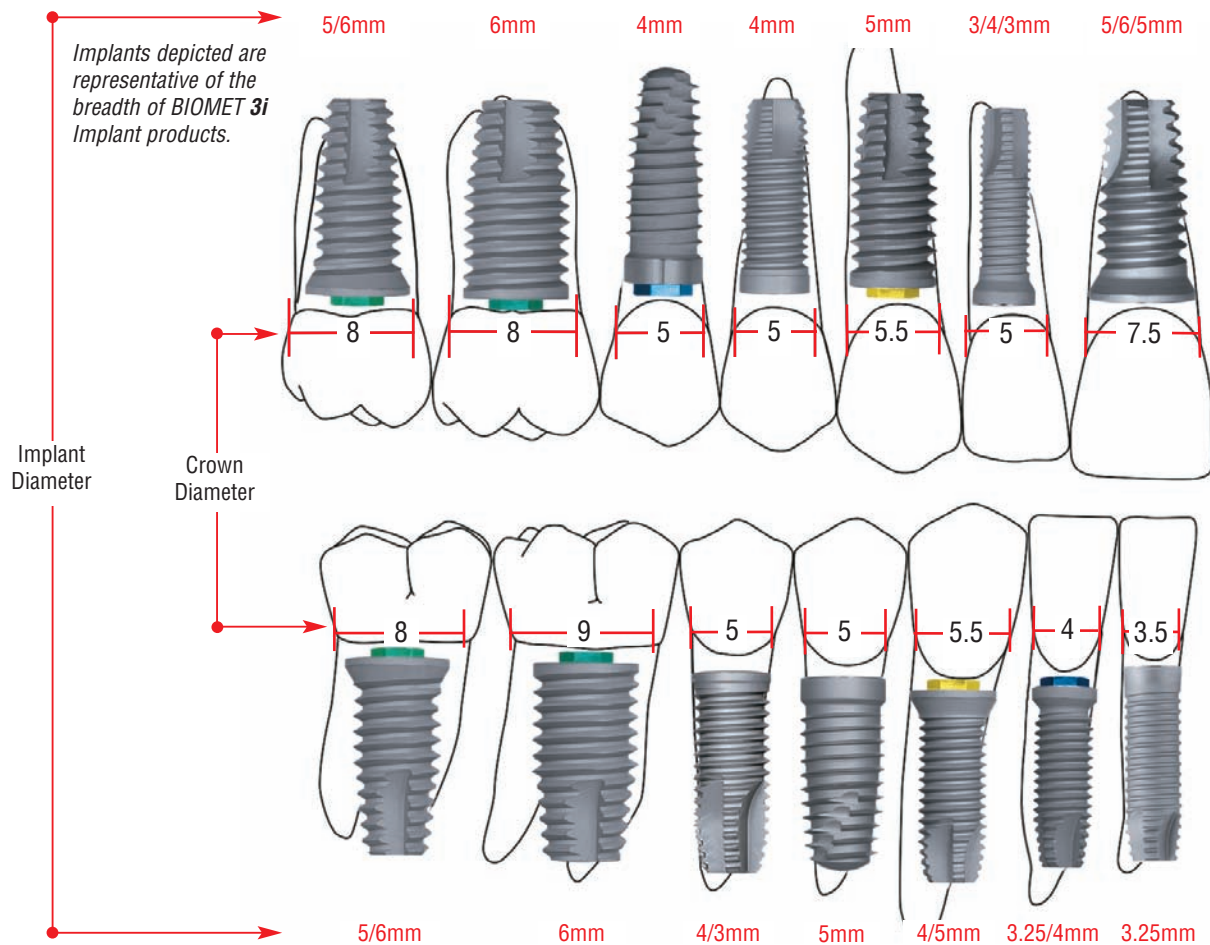

Implants

Certain® Internal Connection

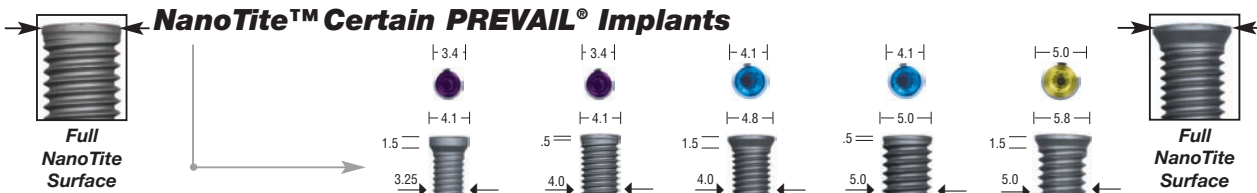

Length	3/4/3mm (P)	4/3mm (P)	4/5/4mm (P)	5/4mm (P)	5/6/5mm (P)
8.5mm	NIIOS3485	NIIOS4385	NIIOS4585	NIIOS5485	NIIOS5685
10.0mm	NIIOS3410	NIIOS4310	NIIOS4510	NIIOS5410	NIIOS5610
11.5mm	NIIOS3411	NIIOS4311	NIIOS4511	NIIOS5411	NIIOS5611
13.0mm	NIIOS3413	NIIOS4313	NIIOS4513	NIIOS5413	NIIOS5613
15.0mm	NIIOS3415	NIIOS4315	NIIOS4515	NIIOS5415	NIIOS5615
Cover Screw Flat (included)	IMCSF34	IMCSF34	ICSF41	ICSF41	ICSF50
Cover Screw Headless	N/A	N/A	ICS275	ICS275	ICS275
Cover Screw 1mm(H)	IMMCS1	IMMCS1	ICS375	ICS375	ICS500

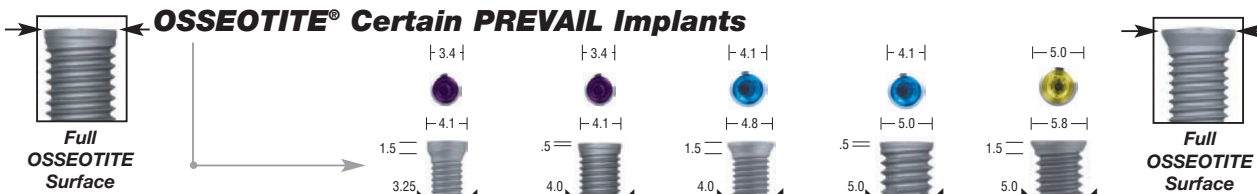

Length	3/4/3mm (P)	4/3mm (P)	4/5/4mm (P)	5/4mm (P)	5/6/5mm (P)
8.5mm	IIOS3485	IIOS4385	IIOS4585	IIOS5485	IIOS5685
10.0mm	IIOS3410	IIOS4310	IIOS4510	IIOS5410	IIOS5610
11.5mm	IIOS3411	IIOS4311	IIOS4511	IIOS5411	IIOS5611
13.0mm	IIOS3413	IIOS4313	IIOS4513	IIOS5413	IIOS5613
15.0mm	IIOS3415	IIOS4315	IIOS4515	IIOS5415	IIOS5615
Cover Screw Flat (included)	IMCSF34	IMCSF34	ICSF41	ICSF41	ICSF50
Cover Screw Headless	N/A	N/A	ICS275	ICS275	ICS275
Cover Screw 1mm(H)	IMMCS1	IMMCS1	ICS375	ICS375	ICS500

All indicated measurements are in millimeters.



Some products may not be available outside of the United States.
 Algunos productos no se comercializan fuera de EE.UU.
 Certains produits ne sont pas disponibles en dehors des États-Unis.
 Einige Produkte sind außerhalb der USA nicht erhältlich.

Implants

Certain® Internal Connection

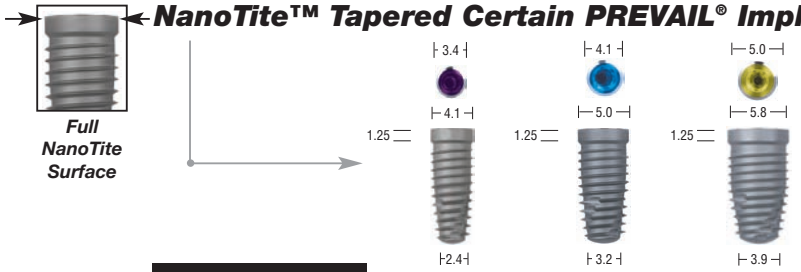
NanoTite™ Tapered Certain PREVAIL® Implants*





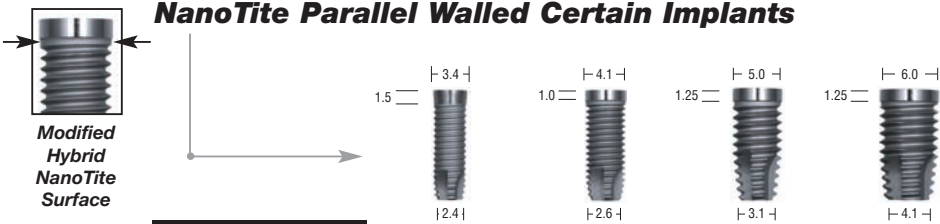

Length	4/3mm (P)	5/4mm (P)	6/5mm (P)
8.5mm	NIITP4385	NIITP5485	NIITP6585
10.0mm	NIITP4310	NIITP5410	NIITP6510
11.5mm	NIITP4311	NIITP5411	NIITP6511
13.0mm	NIITP4313	NIITP5413	NIITP6513
15.0mm	NIITP4315	NIITP5415	NIITP6515
Cover Screw Flat (included)	 IMCSF34	 ICSF41	 ICSF50
Cover Screw Headless	N/A	ICS275	ICS275
Cover Screw 1mm(H)	IMMCS1	ICS375	ICS500

*Only available in NanoTite Implant Surface Configurations.

NanoTite Parallel Walled Certain Implants



Length	3.25mm (D)	4.0mm (D)	5.0mm (D)	6.0mm (D)
8.5mm	NIOSM385	NIOSS485	NIOSS585	NIOSS685
10.0mm	NIOSM310	NIOSS410	NIOSS510	NIOSS610
11.5mm	NIOSM311	NIOSS411	NIOSS511	NIOSS611
13.0mm	NIOSM313	NIOSS413	NIOSS513	NIOSS613
15.0mm	NIOSM315	NIOSS415	NIOSS515	NIOSS615
18.0mm	NIOSM318	NIOSS418	N/A	N/A
Cover Screw 1mm(H) (included)	 IMMCS1	 ICS375*	 ICS500	 ICS600
Cover Screw Headless	N/A	ICS275	ICS275	ICS275
Cover Screw Flat	IMCSF34	ICSF41	ICSF50	ICSF60

*Non-Flared 4.1mm(P) Cover Screw ICS400 also available.

All indicated measurements are in millimeters.

Some products may not be available outside of the United States.
 Algunos productos no se comercializan fuera de EE.UU.
 Certains produits ne sont pas disponibles en dehors des États-Unis.
 Einige Produkte sind außerhalb der USA nicht erhältlich.

Implants

Certain® Internal Connection

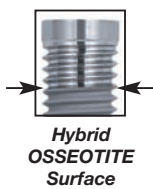

OSSEOTITE® Parallel Walled Certain Implants

Length	3.25mm (D)	4.0mm (D)	5.0mm (D)	6.0mm (D)	4/5mm (P)	5/6mm (P)
8.5mm	IOSM385	IOSS485	IOSS585	IOSS685	IOS4585	IOS5685
10.0mm	IOSM310	IOSS410	IOSS510	IOSS610	IOS4510	IOS5610
11.5mm	IOSM311	IOSS411	IOSS511	IOSS611	IOS4511	IOS5611
13.0mm	IOSM313	IOSS413	IOSS513	IOSS613	IOS4513	IOS5613
15.0mm	IOSM315	IOSS415	IOSS515	IOSS615	IOS4515	IOS5615
18.0mm	IOSM318	IOSS418	N/A	N/A	N/A	N/A
20.0mm	N/A	IOSS420	N/A	N/A	N/A	N/A

OSSEOTITE XP® (Expanded Platform) Certain Implants

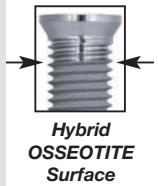

Full OSSEOTITE Parallel Walled Certain Implants

8.5mm	IFOSM385	IFOS485	IFOS585	IFOS685	IFOS4585	IFOS5685
10.0mm	IFOSM310	IFOS410	IFOS510	IFOS610	IFOS4510	IFOS5610
11.5mm	IFOSM311	IFOS411	IFOS511	IFOS611	IFOS4511	IFOS5611
13.0mm	IFOSM313	IFOS413	IFOS513	IFOS613	IFOS4513	IFOS5613
15.0mm	IFOSM315	IFOS415	IFOS515	IFOS615	IFOS4515	IFOS5615

Full OSSEOTITE XP Certain Implants

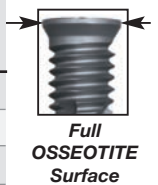

Cover Screw 1mm(H) (included)	 IMMCS1	 ICS375*	 ICS500	 ICS600	 ICS500	 ICS600
Cover Screw Headless	N/A	ICS275	ICS275	ICS275	ICS275	ICS275
Cover Screw Flat	IMCSF34	ICSF41	ICSF50	ICSF60	ICSF50	ICSF60

*Non-Flared 4.1mm(P) Cover Screw ICS400 also available.

All indicated measurements are in millimeters.

Some products may not be available outside of the United States.
Algunos productos no se comercializan fuera de EE.UU.
Certains produits ne sont pas disponibles en dehors des États-Unis.
Einige Produkte sind außerhalb der USA nicht erhältlich.

Implants

Certain® Internal Connection

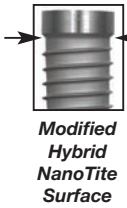

NanoTite™ Tapered Certain Implants

Length	3.25mm (D)	4.0mm (D)	5.0mm (D)	6.0mm (D)
8.5mm	NINT3285	NINT485	NINT585	NINT685
10.0mm	NINT3210	NINT410	NINT510	NINT610
11.5mm	NINT3211	NINT411	NINT511	NINT611
13.0mm	NINT3213	NINT413	NINT513	NINT613
15.0mm	NINT3215	NINT415	NINT515	NINT615

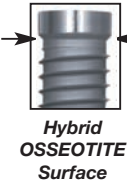

OSSEOTITE® Tapered Certain Implants

Length	3.25mm (D)	4.0mm (D)	5.0mm (D)	6.0mm (D)
8.5mm	INT3285	INT485	INT585	INT685
10.0mm	INT3210	INT410	INT510	INT610
11.5mm	INT3211	INT411	INT511	INT611
13.0mm	INT3213	INT413	INT513	INT613
15.0mm	INT3215	INT415	INT515	INT615



Full OSSEOTITE Tapered Certain Implants

8.5mm	IFNT3285	IFNT485	IFNT585	IFNT685
10.0mm	IFNT3210	IFNT410	IFNT510	IFNT610
11.5mm	IFNT3211	IFNT411	IFNT511	IFNT611
13.0mm	IFNT3213	IFNT413	IFNT513	IFNT613
15.0mm	IFNT3215	IFNT415	IFNT515	IFNT615

Cover Screw 1mm(H) (included)	IMMCS1	ICS375*	ICS500	ICS600
Cover Screw Headless	N/A	ICS275	ICS275	ICS275
Cover Screw Flat	IMCSF34	ICSF41	ICSF50	ICSF60

*Non-Flared 4.1mm(P) Cover Screw ICS400 also available.

All indicated measurements are in millimeters.





Some products may not be available outside of the United States.
 Algunos productos no se comercializan fuera de EE.UU.
 Certains produits ne sont pas disponibles en dehors des États-Unis.
 Einige Produkte sind außerhalb der USA nicht erhältlich.

Implants

External Hex Connection

NanoTite™ Parallel Walled Implants

Modified Hybrid NanoTite Surface

Length	3.25mm (D)	4.0mm (D)	5.0mm (D)	6.0mm (D)
7.0mm	N/A	NOSS407	NOSS507	NOSS607
8.5mm	NOSM385	NOSS485	NOSS585	NOSS685
10.0mm	NOSM310	NOSS410	NOSS510	NOSS610
11.5mm	NOSM311	NOSS411	NOSS511	NOSS611
13.0mm	NOSM313	NOSS413	NOSS513	NOSS613
15.0mm	NOSM315	NOSS415	NOSS515	NOSS615
18.0mm	NOSM318	NOSS418	NOSS518	NOSS618
Cover Screw 1mm(H) (included)	 MMCS1	 CS375	 CS500	 CS600
Cover Screw Headless	CS275	CS275	CS275	CS275

All indicated measurements are in millimeters.

Some products may not be available outside of the United States.
 Algunos productos no se comercializan fuera de EE.UU.
 Certains produits ne sont pas disponibles en dehors des États-Unis.
 Einige Produkte sind außerhalb der USA nicht erhältlich.

Implants

External Hex Connection



Hybrid OSSEOTITE Surface

OSSEOTITE® Parallel Walled Implants

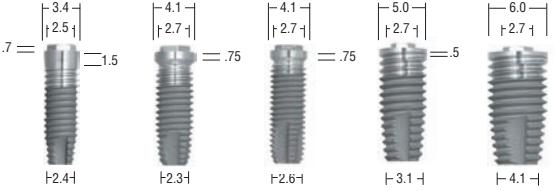

All External Parallel Walled Implant Hex Dimension Heights Measure .7mm

OSSEOTITE XP® (Expanded Platform) Implants

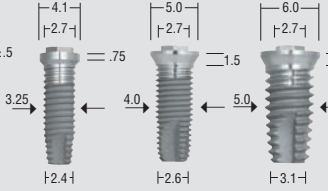

Hybrid OSSEOTITE Surface

Length	3.25mm (D)	3.75mm (D)	4.0mm (D)	5.0mm (D)	6.0mm (D)	3/4mm (P)	4/5mm (P)	5/6mm (P)
7.0mm	N/A	N/A	N/A	OSS507	OSS607	N/A	N/A	N/A
8.5mm	OSM385	OSS385	OSS485	OSS585	OSS685	OS3285	OS4585	OS5685
10.0mm	OSM310	OSS310	OSS410	OSS510	OSS610	OS3210	OS4510	OS5610
11.5mm	OSM311	OSS311	OSS411	OSS511	OSS611	OS3211	OS4511	OS5611
13.0mm	OSM313	OSS313	OSS413	OSS513	OSS613	OS3213	OS4513	OS5613
15.0mm	OSM315	OSS315	OSS415	OSS515	OSS615	OS3215	OS4515	OS5615
18.0mm	OSM318	OSS318	OSS418	OSS518	OSS618	OS3218	N/A	N/A
20.0mm	N/A	OSS320	OSS420	N/A	N/A	N/A	N/A	N/A



Full OSSEOTITE Surface

Full OSSEOTITE Parallel Walled Implants

Full OSSEOTITE XP Implants

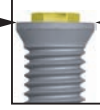

Full OSSEOTITE Surface

7.0mm	FOSM307	FOS307	FOS407	FOS507	FOS607	FOS3207	FOS4507	FOS5607
8.5mm	FOSM385	FOS385	FOS485	FOS585	FOS685	FOS3285	FOS4585	FOS5685
10.0mm	FOSM310	FOS310	FOS410	FOS510	FOS610	FOS3210	FOS4510	FOS5610
11.5mm	FOSM311	FOS311	FOS411	FOS511	FOS611	FOS3211	FOS4511	FOS5611
13.0mm	FOSM313	FOS313	FOS413	FOS513	FOS613	FOS3213	FOS4513	FOS5613
15.0mm	FOSM315	FOS315	FOS415	FOS515	FOS615	FOS3215	FOS4515	FOS5615

Cover Screw 1mm(H) (included)								
	MMCS1	CS375	CS375	CS500	CS600	CS375	CS500	CS600
Cover Screw Headless								
	CS275	CS275	CS275	CS275	CS275	CS275	CS275	CS275

All indicated measurements are in millimeters.

Some products may not be available outside of the United States.
 Algunos productos no se comercializan fuera de EE.UU.
 Certains produits ne sont pas disponibles en dehors des États-Unis.
 Einige Produkte sind außerhalb der USA nicht erhältlich.



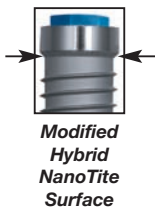

Implants

External Hex Connection

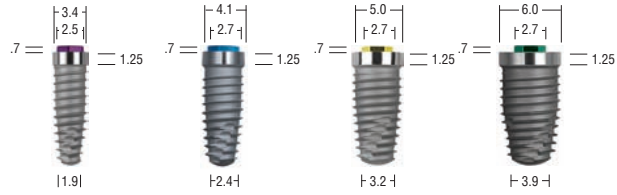

NanoTite™ Tapered Implants



Length	3.25mm (D)	4.0mm (D)	5.0mm (D)	6.0mm (D)
8.5mm	NNT3285	NNT485	NNT585	NNT685
10.0mm	NNT3210	NNT410	NNT510	NNT610
11.5mm	NNT3211	NNT411	NNT511	NNT611
13.0mm	NNT3213	NNT413	NNT513	NNT613
15.0mm	NNT3215	NNT415	NNT515	NNT615
Cover Screw 1mm(H) (included)	 MMCS1	 CS375	 CS500	 CS600
Cover Screw Headless	CS275	CS275	CS275	CS275

All indicated measurements are in millimeters.

Some products may not be available outside of the United States.
 Algunos productos no se comercializan fuera de EE.UU.
 Certains produits ne sont pas disponibles en dehors des États-Unis.
 Einige Produkte sind außerhalb der USA nicht erhältlich.

Implants

External Hex Connection

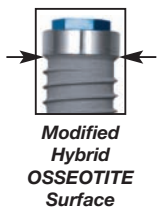

OSSEOTITE® Tapered Implants

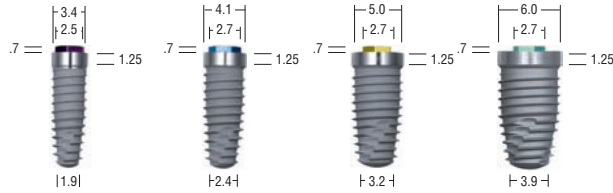

Length	3.25mm (D)	4.0mm (D)	5.0mm (D)	6.0mm (D)
8.5mm	NT3285	NT485	NT585	NT685
10.0mm	NT3210	NT410	NT510	NT610
11.5mm	NT3211	NT411	NT511	NT611
13.0mm	NT3213	NT413	NT513	NT613
15.0mm	NT3215	NT415	NT515	NT615

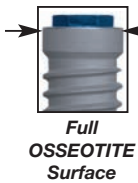

Full OSSEOTITE Tapered Implants

8.5mm	FNT3285	FNT485	FNT585	FNT685
10.0mm	FNT3210	FNT410	FNT510	FNT610
11.5mm	FNT3211	FNT411	FNT511	FNT611
13.0mm	FNT3213	FNT413	FNT513	FNT613
15.0mm	FNT3215	FNT415	FNT515	FNT615

Cover Screw 1mm(H) (included)	MMCS1	CS375	CS500	CS600
Cover Screw Headless	CS275	CS275	CS275	CS275

All indicated measurements are in millimeters.

Some products may not be available outside of the United States.
 Algunos productos no se comercializan fuera de EE.UU.
 Certains produits ne sont pas disponibles en dehors des États-Unis.
 Einige Produkte sind außerhalb der USA nicht erhältlich.

Healing Abutments

Certain® Internal Connection

ARCHITECH PSR®

Encode® Two-Piece Healing Abutments



Occlusal markings provide scanner information for abutment design.

3.4mm Seating Surface



Emergence Profile	Collar Height	Item Numbers
3.8mm	3.0mm	IEHA343
3.8mm	4.0mm	IEHA344
3.8mm	6.0mm	IEHA346
3.8mm	8.0mm	IEHA348
5.0mm	3.0mm	IEHA353
5.0mm	4.0mm	IEHA354
5.0mm	6.0mm	IEHA356
5.0mm	8.0mm	IEHA358

4.1mm Seating Surface

Emergence Profile	Collar Height	Item Numbers
4.1mm	3.0mm	IEHA443
4.1mm	4.0mm	IEHA444
4.1mm	6.0mm	IEHA446
4.1mm	8.0mm	IEHA448
5.0mm	3.0mm	IEHA453
5.0mm	4.0mm	IEHA454
5.0mm	6.0mm	IEHA456
5.0mm	8.0mm	IEHA458
6.0mm	3.0mm	IEHA463
6.0mm	4.0mm	IEHA464
6.0mm	6.0mm	IEHA466
6.0mm	8.0mm	IEHA468
7.5mm	3.0mm	IEHA473
7.5mm	4.0mm	IEHA474
7.5mm	6.0mm	IEHA476
7.5mm	8.0mm	IEHA478

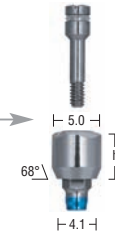
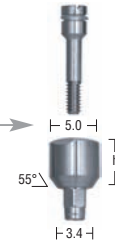

The **Encode Impression System** eliminates the need for an implant-level impression while delivering a Patient Specific Restoration® that has the appropriate margin height and natural emergence contours for the patient. This accuracy is achieved from an impression of the Encode Healing Abutment. Codes embedded on the occlusal surface of the Encode Healing Abutment communicate the collar height, implant hex-orientation, platform diameter and interface (the Certain Internal Connection or External Hex Connection) of the implant. Because the tissue is healed at the time of impression, the margin should have the appropriate placement and contour. The result is a patient specific, anatomically designed, final Encode Abutment. Available in titanium, titanium nitride coating and zirconia.

All indicated measurements are in millimeters.

Some products may not be available outside of the United States.
 Algunos productos no se comercializan fuera de EE.UU.
 Certains produits ne sont pas disponibles en dehors des États-Unis.
 Einige Produkte sind außerhalb der USA nicht erhältlich.

Healing Abutments

Certain® Internal Connection

ARCHITECH PSR®

Encode® Two-Piece Healing Abutments

5.0mm Seating Surface



Emergence Profile	Collar Height	Item Numbers
5.6mm	3.0mm	IEHA553
5.6mm	4.0mm	IEHA554
5.6mm	6.0mm	IEHA556
5.6mm	8.0mm	IEHA558
6.0mm	3.0mm	IEHA563
6.0mm	4.0mm	IEHA564
6.0mm	6.0mm	IEHA566
6.0mm	8.0mm	IEHA568
7.5mm	3.0mm	IEHA573
7.5mm	4.0mm	IEHA574
7.5mm	6.0mm	IEHA576
7.5mm	8.0mm	IEHA578

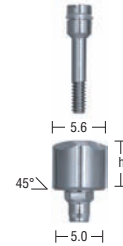

6.0mm Seating Surface

Emergence Profile	Collar Height	Item Numbers
6.8mm	3.0mm	IEHA663
6.8mm	4.0mm	IEHA664
6.8mm	6.0mm	IEHA666
6.8mm	8.0mm	IEHA668
7.5mm	3.0mm	IEHA673
7.5mm	4.0mm	IEHA674
7.5mm	6.0mm	IEHA676
7.5mm	8.0mm	IEHA678

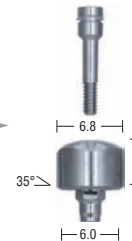

Certain Internal Connection

All indicated measurements are in millimeters.

Some products may not be available outside of the United States.
 Algunos productos no se comercializan fuera de EE.UU.
 Certains produits ne sont pas disponibles en dehors des États-Unis.
 Einige Produkte sind außerhalb der USA nicht erhältlich.



Healing Abutments

Certain® Internal Connection

EP® One-Piece Healing Abutments

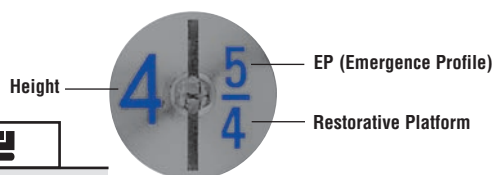

3.4mm Seating Surface

Emergence Profile	Collar Height	Item Numbers
3.4mm	2.0mm	ISMHA32
3.4mm	3.0mm	ISMHA33
3.4mm	4.0mm	ISMHA34
3.4mm	6.0mm	ISMHA36
3.8mm	2.0mm	IMHA32
3.8mm	3.0mm	IMHA33
3.8mm	4.0mm	IMHA34
3.8mm	6.0mm	IMHA36

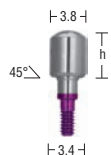

4.1mm Seating Surface

Emergence Profile	Collar Height	Item Numbers
4.1mm	2.0mm	ISHA42
4.1mm	3.0mm	ISHA43
4.1mm	4.0mm	ISHA44
4.1mm	6.0mm	ISHA46
4.1mm	8.0mm	ISHA48
5.0mm	2.0mm	ITHA52
5.0mm	3.0mm	ITHA53
5.0mm	4.0mm	ITHA54
5.0mm	6.0mm	ITHA56
5.0mm	8.0mm	ITHA58
6.0mm	3.0mm	ITHA63
6.0mm	4.0mm	ITHA64
6.0mm	6.0mm	ITHA66
6.0mm	8.0mm	ITHA68
7.5mm	3.0mm	ITHA73
7.5mm	4.0mm	ITHA74
7.5mm	6.0mm	ITHA76
7.5mm	8.0mm	ITHA78

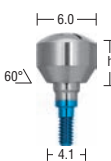
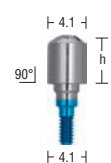

All indicated measurements are in millimeters.

Some products may not be available outside of the United States.
Algunos productos no se comercializan fuera de EE.UU.
Certains produits ne sont pas disponibles en dehors des États-Unis.
Einige Produkte sind außerhalb der USA nicht erhältlich.

Healing Abutments

Certain® Internal Connection

EP® One-Piece Healing Abutments

5.0mm Seating Surface

Emergence Profile	Collar Height	Item Numbers
5.0mm	2.0mm	ISWHA52
5.0mm	3.0mm	ISWHA53
5.0mm	4.0mm	ISWHA54
5.0mm	6.0mm	ISWHA56
5.0mm	8.0mm	ISWHA58
5.6mm	2.0mm	IWTH52
5.6mm	3.0mm	IWTH53
5.6mm	4.0mm	IWTH54
5.6mm	6.0mm	IWTH56
5.6mm	8.0mm	IWTH58
6.0mm	2.0mm	IWTH562
6.0mm	3.0mm	IWTH563
6.0mm	4.0mm	IWTH564
6.0mm	6.0mm	IWTH566
6.0mm	8.0mm	IWTH568
7.5mm	2.0mm	IWTH572
7.5mm	3.0mm	IWTH573
7.5mm	4.0mm	IWTH574
7.5mm	6.0mm	IWTH576
7.5mm	8.0mm	IWTH578

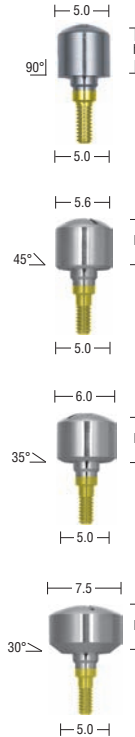

6.0mm Seating Surface

Emergence Profile	Collar Height	Item Numbers
6.0mm	2.0mm	ISWHA62
6.0mm	3.0mm	ISWHA63
6.0mm	4.0mm	ISWHA64
6.0mm	6.0mm	ISWHA66
6.0mm	8.0mm	ISWHA68
6.8mm	2.0mm	IWTH62
6.8mm	3.0mm	IWTH63
6.8mm	4.0mm	IWTH64
6.8mm	6.0mm	IWTH66
6.8mm	8.0mm	IWTH68
7.5mm	2.0mm	IWTH672
7.5mm	3.0mm	IWTH673
7.5mm	4.0mm	IWTH674
7.5mm	6.0mm	IWTH676
7.5mm	8.0mm	IWTH678

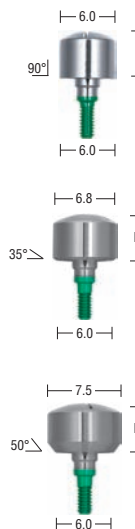

All indicated measurements are in millimeters.

Some products may not be available outside of the United States.
 Algunos productos no se comercializan fuera de EE.UU.
 Certains produits ne sont pas disponibles en dehors des États-Unis.
 Einige Produkte sind außerhalb der USA nicht erhältlich.

Healing Abutments

External Hex Connection



Occlusal markings provide scanner information for abutment design.

ARCHITECH[®] PSR[®]

Encode[®] Two-Piece Healing Abutments

3.4mm Seating Surface		
Emergence Profile	Collar Height	Item Numbers
3.8mm	3.0mm	EHA343
3.8mm	4.0mm	EHA344
3.8mm	6.0mm	EHA346
3.8mm	8.0mm	EHA348
5.0mm	3.0mm	EHA353
5.0mm	4.0mm	EHA354
5.0mm	6.0mm	EHA356
5.0mm	8.0mm	EHA358
4.1mm Seating Surface		
Emergence Profile	Collar Height	Item Numbers
4.1mm	3.0mm	EHA443
4.1mm	4.0mm	EHA444
4.1mm	6.0mm	EHA446
4.1mm	8.0mm	EHA448
5.0mm	3.0mm	EHA453
5.0mm	4.0mm	EHA454
5.0mm	6.0mm	EHA456
5.0mm	8.0mm	EHA458
6.0mm	3.0mm	EHA463
6.0mm	4.0mm	EHA464
6.0mm	6.0mm	EHA466
6.0mm	8.0mm	EHA468
7.5mm	3.0mm	EHA473
7.5mm	4.0mm	EHA474
7.5mm	6.0mm	EHA476
7.5mm	8.0mm	EHA478

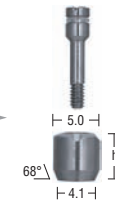
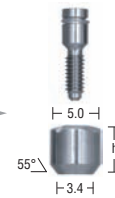

All indicated measurements are in millimeters.

Some products may not be available outside of the United States.
 Algunos productos no se comercializan fuera de EE.UU.
 Certains produits ne sont pas disponibles en dehors des États-Unis.
 Einige Produkte sind außerhalb der USA nicht erhältlich.

Healing Abutments

External Hex Connection

ARCHITECH PSR®

Encode® Two-Piece Healing Abutments

5.0mm Seating Surface



Emergence Profile	Collar Height	Item Numbers
5.6mm	3.0mm	EHA553
5.6mm	4.0mm	EHA554
5.6mm	6.0mm	EHA556
5.6mm	8.0mm	EHA558
6.0mm	3.0mm	EHA563
6.0mm	4.0mm	EHA564
6.0mm	6.0mm	EHA566
6.0mm	8.0mm	EHA568
7.5mm	3.0mm	EHA573
7.5mm	4.0mm	EHA574
7.5mm	6.0mm	EHA576
7.5mm	8.0mm	EHA578

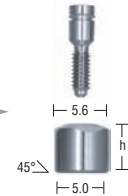

6.0mm Seating Surface

Emergence Profile	Collar Height	Item Numbers
6.8mm	3.0mm	EHA663
6.8mm	4.0mm	EHA664
6.8mm	6.0mm	EHA666
6.8mm	8.0mm	EHA668
7.5mm	3.0mm	EHA673
7.5mm	4.0mm	EHA674
7.5mm	6.0mm	EHA676
7.5mm	8.0mm	EHA678

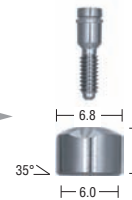

All indicated measurements are in millimeters.

Some products may not be available outside of the United States.
 Algunos productos no se comercializan fuera de EE.UU.
 Certains produits ne sont pas disponibles en dehors des États-Unis.
 Einige Produkte sind außerhalb der USA nicht erhältlich.

Healing Abutments

External Hex Connection

EP® One-Piece Healing Abutments

3.4mm Seating Surface

Emergence Profile	Collar Height	Item Numbers
3.8mm	2.0mm	MHA32
3.8mm	3.0mm	MHA33
3.8mm	4.0mm	MHA34
3.8mm	6.0mm	MHA36

4.1mm Seating Surface

Emergence Profile	Collar Height	Item Numbers
4.1mm	2.0mm	THA42
4.1mm	3.0mm	THA43
4.1mm	4.0mm	THA44
4.1mm	6.0mm	THA46
4.1mm	8.0mm	THA48
5.0mm	2.0mm	THA52
5.0mm	3.0mm	THA53
5.0mm	4.0mm	THA54
5.0mm	6.0mm	THA56
5.0mm	8.0mm	THA58
6.0mm	3.0mm	THA63
6.0mm	4.0mm	THA64
6.0mm	6.0mm	THA66
6.0mm	8.0mm	THA68
7.5mm	3.0mm	THA73
7.5mm	4.0mm	THA74
7.5mm	6.0mm	THA76
7.5mm	8.0mm	THA78

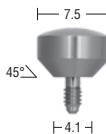
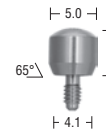
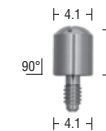
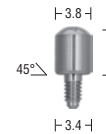
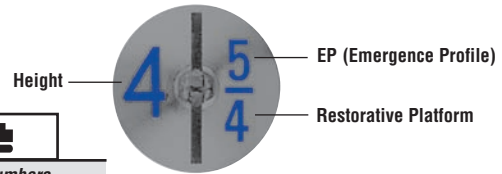

Temporary Healing Retention Cylinder

Retains denture with soft tissue liner.

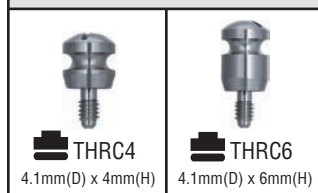

All indicated measurements are in millimeters.

Some products may not be available outside of the United States.
 Algunos productos no se comercializan fuera de EE.UU.
 Certains produits ne sont pas disponibles en dehors des États-Unis.
 Einige Produkte sind außerhalb der USA nicht erhältlich.

Healing Abutments

External Hex Connection

EP® One-Piece Healing Abutments

5.0mm Seating Surface



Emergence Profile	Collar Height	Item Numbers
5.6mm	2.0mm	WTH52
5.6mm	3.0mm	WTH53
5.6mm	4.0mm	WTH54
5.6mm	6.0mm	WTH56
5.6mm	8.0mm	WTH58
6.0mm	2.0mm	WTH562
6.0mm	3.0mm	WTH563
6.0mm	4.0mm	WTH564
6.0mm	6.0mm	WTH566
6.0mm	8.0mm	WTH568
7.5mm	2.0mm	WTH572
7.5mm	3.0mm	WTH573
7.5mm	4.0mm	WTH574
7.5mm	6.0mm	WTH576
7.5mm	8.0mm	WTH578

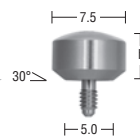
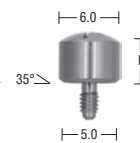
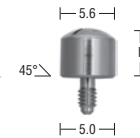

6.0mm Seating Surface

Emergence Profile	Collar Height	Item Numbers
6.8mm	2.0mm	WTH62
6.8mm	3.0mm	WTH63
6.8mm	4.0mm	WTH64
6.8mm	6.0mm	WTH66
6.8mm	8.0mm	WTH68
7.5mm	2.0mm	WTH672
7.5mm	3.0mm	WTH673
7.5mm	4.0mm	WTH674
7.5mm	6.0mm	WTH676
7.5mm	8.0mm	WTH678

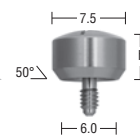
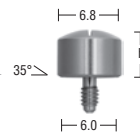

All indicated measurements are in millimeters.

Some products may not be available outside of the United States.
 Algunos productos no se comercializan fuera de EE.UU.
 Certains produits ne sont pas disponibles en dehors des États-Unis.
 Einige Produkte sind außerhalb der USA nicht erhältlich.

Healing Abutments

External Hex Connection

EP®

Two-Piece Healing Abutments

3.4mm Seating Surface

Emergence Profile	Collar Height	Item Numbers
3.8mm	3.0mm	MT233
3.8mm	4.0mm	MT234
3.8mm	6.0mm	MT236
5.0mm	3.0mm	MT253
5.0mm	4.0mm	MT254
5.0mm	6.0mm	MT256

4.1mm Seating Surface

Emergence Profile	Collar Height	Item Numbers
5.0mm	3.0mm	TH253
5.0mm	4.0mm	TH254
5.0mm	6.0mm	TH256
5.0mm	8.0mm	TH258
6.0mm	3.0mm	TH263
6.0mm	4.0mm	TH264
6.0mm	6.0mm	TH266
6.0mm	8.0mm	TH268
7.5mm	3.0mm	TH273
7.5mm	4.0mm	TH274
7.5mm	6.0mm	TH276
7.5mm	8.0mm	TH278

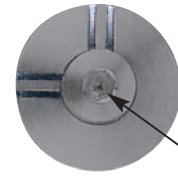

Occlusal identification marks designate abutment's transgingival height based on number of lines not including the dome portion (e.g. 4 lines = 4.0mm).

.048

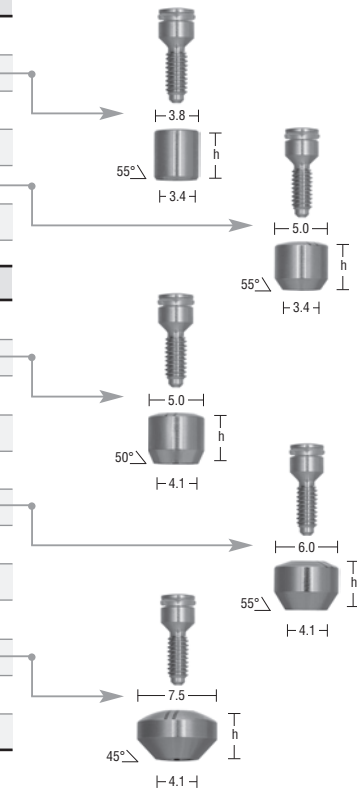

All indicated measurements are in millimeters.

Some products may not be available outside of the United States.
 Algunos productos no se comercializan fuera de EE.UU.
 Certains produits ne sont pas disponibles en dehors des États-Unis.
 Einige Produkte sind außerhalb der USA nicht erhältlich.

Healing Abutments

External Hex Connection

EP®

Two-Piece Healing Abutments

5.0mm Seating Surface

Emergence Profile	Collar Height	Item Numbers
5.6mm	3.0mm	WT2553
5.6mm	4.0mm	WT2554
5.6mm	6.0mm	WT2556
5.6mm	8.0mm	WT2558
6.0mm	3.0mm	WT2563
6.0mm	4.0mm	WT2564
6.0mm	6.0mm	WT2566
6.0mm	8.0mm	WT2568
7.5mm	3.0mm	WT2573
7.5mm	4.0mm	WT2574
7.5mm	6.0mm	WT2576
7.5mm	8.0mm	WT2578

6.0mm Seating Surface

Emergence Profile	Collar Height	Item Numbers
6.8mm	3.0mm	WT2663
6.8mm	4.0mm	WT2664
6.8mm	6.0mm	WT2666
6.8mm	8.0mm	WT2668
7.5mm	3.0mm	WT2673
7.5mm	4.0mm	WT2674
7.5mm	6.0mm	WT2676
7.5mm	8.0mm	WT2678

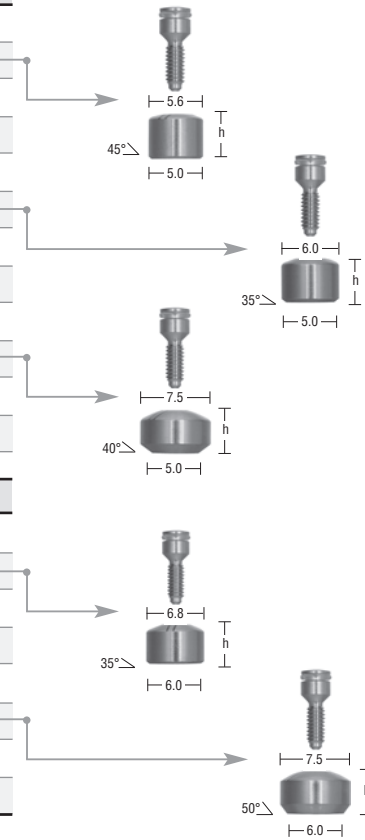

All indicated measurements are in millimeters.

Some products may not be available outside of the United States.
 Algunos productos no se comercializan fuera de EE.UU.
 Certains produits ne sont pas disponibles en dehors des États-Unis.
 Einige Produkte sind außerhalb der USA nicht erhältlich.

BIOMET 3i™
 PROVIDING SOLUTIONS - ONE PATIENT AT A TIME™

Site Preparation Technologies

Product Overview



Navigator Surgical Kit



Navigator Laboratory Kit



OSSEOCISION Drilling Unit



DU900 Drilling Unit

The Navigator® System For CT Guided Surgery

The Navigator System offers the instrumentation that clinicians need to transform computer-based planning into practical implant placement with an opportunity for immediate provisionalization.

The Navigator System enables placement and restoration of the following BIOMET *3i* Parallel Walled Implant Systems:

- Certain® 3.25, 4 and 5mm Implants
- PREVAIL® 3/4/3 and 4/5/4 Implants
- OSSEOTITE XP® 4/5 Implants
- Straight PREVAIL 4/3 and 5/4 Implants

Features specific to the Navigator System include:

- Depth-specific instrumentation for preparation and implant placement
- Control of hex-orientation to fabricate and deliver provisional restorations immediately following surgery
- Open architecture compatibility that provides freedom to choose among leading planning software solutions

OSSEOCISION® And DU900 Surgical Drilling Units

Both OSSEOCISION and DU900 Drilling Units accept twist drills, shaping drills and implant drivers. The units power these instruments for creating the osteotomy for implant placement.

- Ergonomic Handpiece design
- Customized programs for every stage of dental implant surgical procedures
- Foot control for hands free program and setting selections

Site Preparation Technologies

Product Overview



Advanced Cutting Technology® (ACT®) Drills

- Two flute design for efficient cutting
- Alternating lines and bands enhance depth mark visibility and drill orientation in the osteotomy
- Matte finish to reduce glare

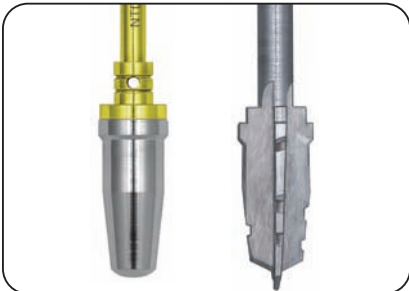

Tapered Implant Depth Indicators And Quad Shaping Drills

- Tapered Implant Depth Indicators (NTDIs) verify the position of the implant platform prior to placement
- Quad Shaping Drills (QSDs) use stepped depth marks for accuracy in creating the osteotomy
- QSDs have end cutting ability
- Both QSDs and NTDIs are color-coded for platform recognition

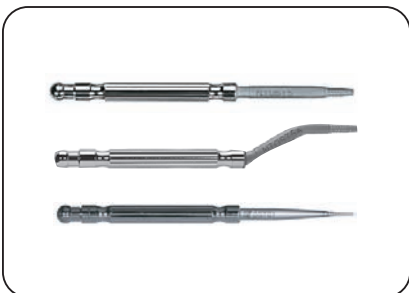

Summers Osteotomes And Tapered Osteotomes

- Summers Osteotomes for use with parallel walled implants
- Tapered Osteotomes available in straight and angled designs for use with tapered implants
- Matte finished tip surface to reduce glare
- Ball striking end to facilitate use of a mallet

Site Preparation Technologies



DU900 Surgical Drilling Unit

Description	Item Numbers
DU900 Surgical Drilling Unit 110–130 volt 220 volt	DU900US DU900EU*
Accessories Included With The DU900:	
Spray Cap With Nozzle - Spray cap for service oil	DU9SC
20:1 Handpiece - 20:1 Gear Reduction Handpiece for the DU900	DU9WS75
Micromotor With Cord - 1.8mm long motor cord plugs into the DU900 Console and attaches to a DU900 Handpiece	DU9MC
Motor Cord Sterilization Protector - Component placed over the end of a DU9MC during sterilization as a moisture barrier	DU9SP
Tube Clamps (5-pack) - Holds irrigation tubing to motor cord (DU9MC)	DU9CL
Foot Control - Connects to DU900 Console to provide foot activation for the doctor	DU9FC
Pump Tubing (3-pack) - Replacement tubing for DU9PTC, without connectors	DU9PT
Pump Tubing, Complete - Placed in irrigation pump on console and connects to DU900 Spike Assembly, DU9SA and irrigation tube (DU9IT)	DU9PTC
Power Cord - Connects to DU900 Console for 110–130 volt use	DU9PCUS
Power Cord - Connects to DU900 Console for 220 volt use	DU9TCEU*
Fuse - Circuit fuse for the DU900 Console	DU9F
Y-Connector Tubes (2-pack) - Attaches between the Y-connector, DU9YC, and the internal DU9CTC and external irrigation tubes to carry irrigant	DU9CH2
Internal Irrigation Tube, Complete - “L” shaped tube that fits through the handpiece head and connects the irrigation tubing, DU9IT and an internally irrigated twist drill	DU9CTC
Y-Connector - Used to bifurcate irrigant flow from irrigation tube, DU9IT, to provide both internal and external irrigation	DU9YC
Disposable Irrigation Tubing/Green (5-box) - Connects between the DU9PTC and the DU900 Handpiece to provide irrigant flow	N/A
Spike Assembly - Connects between the DU9PTC and the irrigation bag	DU9SA
Bur Testing Gauge - Verifies bur/drill shank diameter	DU9BG

The following item is not included in the DU900 Surgical Drilling Unit, but can be ordered separately, as needed, through BIOMET 3i Customer Service.

Disposable Irrigation Tubing/Green (10-box) - Connects between the DU9PTC and the DU900 Handpiece to provide irrigant flow	DU9IT
---	-------

*Not available in the United States.

Some products may not be available outside of the United States.
 Algunos productos no se comercializan fuera de EE.UU.
 Certains produits ne sont pas disponibles en dehors des États-Unis.
 Einige Produkte sind außerhalb der USA nicht erhältlich.

Site Preparation Technologies



OSSEOCISION® Surgical Drilling Unit

Description	Item Numbers
OSSEOCISION Surgical Drilling Unit	
120 volt	DS100US
100 volt	DS100J*
230 volt	DS100RW*

Accessories Included With The OSSEOCISION Surgical Drilling Unit:

Tube Clamp - Holds irrigation tubing to motor cord	C202-750
Internal Irrigation Tube - "L" shaped tube that fits through the handpiece head and connects the irrigation tubing and an internally irrigated component	C293-025
Y-Connector - Used to bifurcate irrigant flow from irrigation tube to provide both internal and external irrigation	C823-752
Micromotor With Cord - Plugs into DS100 Console and attaches to handpiece	E211-001
Bur Testing Gauge - Verifies bur/drill shank diameter	DU9BG
Autoclave Plug For Motor - Used to keep moisture from entering micromotor during sterilization	E211-701
20:1 Handpiece - 20:1 Gear Reduction Handpiece for the DS100	SGM-E20RI
Fuse (100V/120V) - Circuit fuse for DS100 Console (110–130 volt)	U195-152
Fuse (230V) - Circuit fuse for DS100 Console (230 volt)	U197-152*
Coolant Solution Hangar Post - Suspends irrigation bag or bottle from console	U370-152
Control Unit (100V) - DS100J Console	U370-003*
Control Unit (120V) - DS100US Console	U371-003
Control Unit (230V) - DS100RW Console	U372-003*
Electrical Power Cord (100V) - Plugs into DS100J Console and appropriate wall outlet	U389-013*
Electrical Power Cord (120V) - Plugs into DS100US Console and appropriate wall outlet	U166-013
Electrical Power Cord (230V Europe) - Plugs into DS100RW Console and appropriate wall outlet	U260-414*
Electrical Power Cord (230V Australia) - Plugs into DS100RW Console and appropriate wall outlet	U198-013*
Tube Holder - Holds irrigation tubing to handpiece	Y900-083
Irrigation Tubing, Disposable/Clear (5-pack) - Connects between irrigation bag or bottle and handpiece to provide irrigation flow	N/A
Motor Cradle - Supports handpiece when not in use	Z095-102
Handpiece Wench - Used to disassemble handpiece	Z103-101
Spray Lubricant Nozzle - Attaches to lubricant to lubricate handpiece	Z114-090
Nozzle Cleaning Fine Wire - Used to clean handpiece irrigation tube	Z144-095
Foot Control (3.5m) - Connects to DS100 Console to provide foot activation	Z272-004

The following items are not included in the OSSEOCISION Surgical Drilling Unit, but can be ordered separately, as needed, through BIOMET 3i Customer Service.

Motor Cord - Plugs into DS100 Console and attaches to handpiece	E211-051
Irrigation Tubing, Disposable/Clear (10-pack) - Connects between irrigation bag or bottle and handpiece to provide irrigation flow	Y900-114

*Not available in the United States.

Refer to ART984 for the OSSEOCISION Warranty.

Some products may not be available outside of the United States.
 Algunos productos no se comercializan fuera de EE.UU.
 Certains produits ne sont pas disponibles en dehors des États-Unis.
 Einige Produkte sind außerhalb der USA nicht erhältlich.

BIOMET 3i[™]
 PROVIDING SOLUTIONS - ONE PATIENT AT A TIME[™]

Site Preparation Technologies

Disposable Single-Patient-Use Drill Kits

3-Pack Kits - 2.3mm Final Twist Drill

DDK210 7-10mm	DDKN215 7-15mm	DDKN2315 7-15mm	DDK215 7-15mm	DDK220 7-20mm	Description	Item Numbers
•	•	•	•	•	Round Drill, 2mm	DR100
•	•	•	•	•	Pilot Drill, 2–3mm	DP100
	•				Twist Drill, 2mm(D) x 15mm(L) (Non-Hubbed)	DTN215
		•			Twist Drill, 2.3mm(D) x 15mm(L) (Non-Hubbed)	DTN2315
•					Twist Drill, 2.3mm(D) x 10mm(L) (Hubbed)	DT210
			•		Twist Drill, 2.3mm(D) x 15mm(L) (Hubbed)	DT215
				•	Twist Drill, 2.3mm(D) x 20mm(L) (Hubbed)	DT220

5-Pack Kits - 2.75mm Final Twist Drill For Up To 4mm(D) Implants

DDK2710 7-10mm	DDK2715 7-15mm	DDK2720 7-20mm	Description	Item Numbers
•	•	•	Round Drill, 2mm	DR100
•	•	•	Pilot Drill, 2–3mm	DP100
•	•	•	Countersink Drill	DC100
•			Twist Drill, 2.3mm(D) x 10mm(L) (Hubbed)	DT210
	•		Twist Drill, 2.3mm(D) x 15mm(L) (Hubbed)	DT215
		•	Twist Drill, 2.3mm(D) x 20mm(L) (Hubbed)	DT220
•			Twist Drill, 2.75mm(D) x 10mm(L) (Hubbed)	DT2710
	•		Twist Drill, 2.75mm(D) x 15mm(L) (Hubbed)	DT2715
		•	Twist Drill, 2.75mm(D) x 20mm(L) (Hubbed)	DT2720

Some products may not be available outside of the United States.
 Algunos productos no se comercializan fuera de EE.UU.
 Certains produits ne sont pas disponibles en dehors des États-Unis.
 Einige Produkte sind außerhalb der USA nicht erhältlich.

Site Preparation Technologies

Disposable Single-Patient-Use Drill Kits

5-Pack Kits - 3.0mm Final Twist Drill For Up To 4mm(D) Implants

DDK310 7-10mm	DDKN315 7-15mm	DDK315 7-15mm	DDK320 7-20mm	Description	Item Numbers
•	•	•	•	Round Drill, 2mm	DR100
•	•	•	•	Pilot Drill, 2-3mm	DP100
•	•	•	•	Countersink Drill	DC100
	•			Twist Drill, 2mm(D) x 15mm(L) (Non-Hubbed)	DTN215
•				Twist Drill, 2.3mm(D) x 10mm(L) (Hubbed)	DT210
		•		Twist Drill, 2.3mm(D) x 15mm(L) (Hubbed)	DT215
			•	Twist Drill, 2.3mm(D) x 20mm(L) (Hubbed)	DT220
•				Twist Drill, 3mm(D) x 10mm(L) (Hubbed)	DT310
		•		Twist Drill, 3mm(D) x 15mm(L) (Hubbed)	DT315
			•	Twist Drill, 3mm(D) x 20mm(L) (Hubbed)	DT320
	•			Twist Drill, 3mm(D) x 15mm(L) (Non-Hubbed)	DTN315

5-Pack Kits - 3.25mm Final Twist Drill For Up To 4mm(D) Implants

DDK3210 7-10mm	DDK3215 7-15mm	DDK3220 7-20mm	Description	Item Numbers
•	•	•	Round Drill, 2mm	DR100
•	•	•	Pilot Drill, 2-3mm	DP100
•	•	•	Countersink Drill	DC100
•			Twist Drill, 2.3mm(D) x 10mm(L) (Hubbed)	DT210
	•		Twist Drill, 2.3mm(D) x 15mm(L) (Hubbed)	DT215
		•	Twist Drill, 2.3mm(D) x 20mm(L) (Hubbed)	DT220
•			Twist Drill, 3.25mm(D) x 10mm(L) (Hubbed)	DT3210
	•		Twist Drill, 3.25mm(D) x 15mm(L) (Hubbed)	DT3215
		•	Twist Drill, 3.25mm(D) x 20mm(L) (Hubbed)	DT3220

Some products may not be available outside of the United States.
 Algunos productos no se comercializan fuera de EE.UU.
 Certains produits ne sont pas disponibles en dehors des États-Unis.
 Einige Produkte sind außerhalb der USA nicht erhältlich.

Site Preparation Technologies

The Navigator® System For CT Guided Surgery

For Parallel Walled Implants Including:

- Certain® 3.25, 4 and 5mm Implants
- PREVAIL® 3/4/3 and 4/5/4 Implants
- OSSEOTITE XP® 4/5 Implants
- Straight PREVAIL 4/3 and 5/4 Implants



		
SGKIT Surgical Kit	<i>Description</i>	<i>Item Numbers</i>
•	Navigator Surgical Tray	SGTRAY
•	Navigator Tissue Punch, 4.1mm(D)	SGTP4
•	Navigator Tissue Punch, 5mm(D)	SGTP5
•	Navigator Starter Drill, 3.4mm(D)	MSGSD
•	Navigator Starter Drill, 3/4mm(D)	SGSD34
•	Navigator Starter Drill, 4.1mm(D)	SGSD4
•	Navigator Starter Drill, 4/5mm(D)	SGSD45
•	Navigator Certain Starter Drill, 5mm(D)	SGISD5
•	Navigator Twist Drill, 2mm(D) x A(L)	SGD2A
•	Navigator Twist Drill, 2mm(D) x B(L)	SGD2B
•	Navigator Twist Drill, 2mm(D) x C(L)	SGD2C
•	Navigator Twist Drill, 2mm(D) x D(L)	SGD2D
•	Navigator Twist Drill, 2mm(D) x E(L)	SGD2E
•	Navigator Twist Drill, 2.75mm(D) x A(L)	SGD275A
•	Navigator Twist Drill, 2.75mm(D) x B(L)	SGD275B
•	Navigator Twist Drill, 2.75mm(D) x C(L)	SGD275C
•	Navigator Twist Drill, 2.75mm(D) x D(L)	SGD275D
•	Navigator Twist Drill, 2.75mm(D) x E(L)	SGD275E
•	Navigator Twist Drill, 3mm(D) x A(L)	SGD3A
•	Navigator Twist Drill, 3mm(D) x B(L)	SGD3B
•	Navigator Twist Drill, 3mm(D) x C(L)	SGD3C
•	Navigator Twist Drill, 3mm(D) x D(L)	SGD3D
•	Navigator Twist Drill, 3mm(D) x E(L)	SGD3E
•	Navigator Twist Drill, 3.25mm(D) x A(L)	SGD325A
•	Navigator Twist Drill, 3.25mm(D) x B(L)	SGD325B
•	Navigator Twist Drill, 3.25mm(D) x C(L)	SGD325C
•	Navigator Twist Drill, 3.25mm(D) x D(L)	SGD325D
•	Navigator Twist Drill, 3.25mm(D) x E(L)	SGD325E
•	Navigator Twist Drill, 3.85mm(D) x A(L)	SGD385A
•	Navigator Twist Drill, 3.85mm(D) x B(L)	SGD385B
•	Navigator Twist Drill, 3.85mm(D) x C(L)	SGD385C
•	Navigator Twist Drill, 4.25mm(D) x A(L)	SGD425A

Some products may not be available outside of the United States.
 Algunos productos no se comercializan fuera de EE.UU.
 Certains produits ne sont pas disponibles en dehors des États-Unis.
 Einige Produkte sind außerhalb der USA nicht erhältlich.

Site Preparation Technologies

Surgical Kit Cont'd

 SGKIT Surgical Kit	<i>Description</i>	<i>Item Numbers</i>
•	Navigator® Twist Drill, 4.25mm(D) x B(L)	SGD425B
•	Navigator Twist Drill, 4.25mm(D) x C(L)	SGD425C
•	Navigator Bone Tap, 3.25mm(D)	MSGTAP
•	Navigator Bone Tap, 4.1mm(D)	SGTAP4
•	Navigator Bone Tap, 4/5mm(D)	SGTAP45
•	Navigator Bone Tap, 5mm(D)	SGTAP5
•	Navigator Drill Positioning Handle 1	SGDPH1
•	Navigator Drill Positioning Handle 2	SGDPH2
•	Navigator Drill Positioning Handle 3	SGDPH3
•	Navigator Drill Positioning Handle 4	SGDPH4
•	Navigator Drill Positioning Handle 5	SGDPH5
•	Certain® Manual Bone Profiler, 3.4mm(D) x 4.1mm(P)	IMMBP
•	Certain Manual Bone Profiler, 4.1mm(D) x 5mm(P)	IMBP4
•	Certain Manual Bone Profiler, 5mm(D) x 6mm(P)	IMBP5
•	Narrow Right Angle Large Hexed Driver Tip, 24mm	RASH3N
•	Handpiece Connector	MDR10
•	Posterior Large Hexed Driver, 17mm(L)	PHD02N
•	Ratchet Extension – Short, 6mm(L)	RE100
•	Ratchet Extension – Long, 15mm(L)	RE200
•	Navigator Certain Implant Mount, 3.4mm(D) x 1(L)	MSGIIM1
•	Navigator Certain Implant Mount, 3.4mm(D) x 2(L)	MSGIIM2
•	Navigator Certain Implant Mount, 3.4mm(D) x 3(L)	MSGIIM3
•	Navigator Certain Implant Mount, 3.4mm(D) x 4(L)	MSGIIM4
•	Navigator Certain Implant Mount, 4.1mm(D) x 1(L)	SGIIM41
•	Navigator Certain Implant Mount, 4.1mm(D) x 2(L)	SGIIM42
•	Navigator Certain Implant Mount, 4.1mm(D) x 3(L)	SGIIM43
•	Navigator Certain Implant Mount, 4.1mm(D) x 4(L)	SGIIM44
•	Navigator Certain Implant Mount, 5mm(D) x 1(L)	SGIIM51
•	Navigator Certain Implant Mount, 5mm(D) x 2(L)	SGIIM52
•	Navigator Certain Implant Mount, 5mm(D) x 3(L)	SGIIM53
•	Navigator Certain Implant Mount, 5mm(D) x 4(L)	SGIIM54

The following items are not included in the Navigator Surgical Kit, but can be ordered separately, as needed, through BIOMET 3i Customer Service.

<i>Description</i>	<i>Item Numbers</i>	<i>Description</i>	<i>Item Numbers</i>
Navigator Twist Drill, 2mm(D) x Y(L)	SGD2Y	Navigator Twist Drill, 3.25mm(D) x Y(L)	SGD325Y
Navigator Twist Drill, 2mm(D) x Z(L)	SGD2Z	Navigator Twist Drill, 3.25mm(D) x Z(L)	SGD325Z
Navigator Twist Drill, 2.75mm(D) x Y(L)	SGD275Y	Navigator Twist Drill, 3.85mm(D) x Y(L)	SGD385Y
Navigator Twist Drill, 2.75mm(D) x Z(L)	SGD275Z	Navigator Twist Drill, 3.85mm(D) x Z(L)	SGD385Z
Navigator Twist Drill, 3mm(D) x Y(L)	SGD3Y	Navigator Twist Drill, 4.25mm(D) x Y(L)	SGD425Y
Navigator Twist Drill, 3mm(D) x Z(L)	SGD3Z	Navigator Twist Drill, 4.25mm(D) x Z(L)	SGD425Z

Some products may not be available outside of the United States.
 Algunos productos no se comercializan fuera de EE.UU.
 Certains produits ne sont pas disponibles en dehors des États-Unis.
 Einige Produkte sind außerhalb der USA nicht erhältlich.

BIOMET 3i™
 PROVIDING SOLUTIONS – ONE PATIENT AT A TIME™

Site Preparation Technologies

The Navigator® System For CT Guided Surgery

SGLKIT Navigator Laboratory Kit



		
SGLKIT Laboratory Kit	Description	Item Numbers
•	Navigator Laboratory Tray	SGLTRAY
•	Navigator Certain® Analog Mount, 3.4mm(D) x 1(L)	MSGIAM1
•	Navigator Certain Analog Mount, 3.4mm(D) x 2(L)	MSGIAM2
•	Navigator Certain Analog Mount, 3.4mm(D) x 3(L)	MSGIAM3
•	Navigator Certain Analog Mount, 3.4mm(D) x 4(L)	MSGIAM4
•	Navigator Certain Analog Mount, 4.1mm(D) x 1(L)	SGIAM41
•	Navigator Certain Analog Mount, 4.1mm(D) x 2(L)	SGIAM42
•	Navigator Certain Analog Mount, 4.1mm(D) x 3(L)	SGIAM43
•	Navigator Certain Analog Mount, 4.1mm(D) x 4(L)	SGIAM44
•	Navigator Certain Analog Mount, 5mm(D) x 1(L)	SGIAM51
•	Navigator Certain Analog Mount, 5mm(D) x 2(L)	SGIAM52
•	Navigator Certain Analog Mount, 5mm(D) x 3(L)	SGIAM53
•	Navigator Certain Analog Mount, 5mm(D) x 4(L)	SGIAM54

31-3100 BIOMET 2mm Fixation System

To order, call 1-800-874-7711
www.BiometMicrofixation.com





Some products may not be available outside of the United States.
 Algunos productos no se comercializan fuera de EE.UU.
 Certains produits ne sont pas disponibles en dehors des États-Unis.
 Einige Produkte sind außerhalb der USA nicht erhältlich.

Site Preparation Technologies

Tapered Implant Surgical Kits

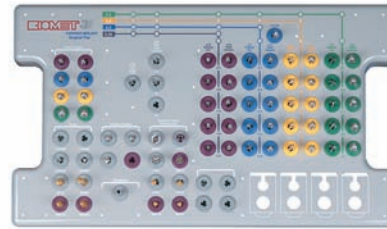
QNTSK40 Premium Kit





 QNTSK40 Premium Kit	 QNTSK40U Upgrade Kit	Description	Item Numbers
•	•	Quad Shaping Drill, 3.25mm(D) x 8.5mm(L)	QSD3285
•	•	Quad Shaping Drill, 3.25mm(D) x 10mm(L)	QSD3210
•	•	Quad Shaping Drill, 3.25mm(D) x 11.5mm(L)	QSD3211
•	•	Quad Shaping Drill, 3.25mm(D) x 13mm(L)	QSD3213
•	•	Quad Shaping Drill, 3.25mm(D) x 15mm(L)	QSD3215
•	•	Quad Shaping Drill, 4mm(D) x 8.5mm(L)	QSD485
•	•	Quad Shaping Drill, 4mm(D) x 10mm(L)	QSD410
•	•	Quad Shaping Drill, 4mm(D) x 11.5mm(L)	QSD411
•	•	Quad Shaping Drill, 4mm(D) x 13mm(L)	QSD413
•	•	Quad Shaping Drill, 4mm(D) x 15mm(L)	QSD415
•	•	Quad Shaping Drill, 5mm(D) x 8.5mm(L)	QSD585
•	•	Quad Shaping Drill, 5mm(D) x 10mm(L)	QSD510
•	•	Quad Shaping Drill, 5mm(D) x 11.5mm(L)	QSD511
•	•	Quad Shaping Drill, 5mm(D) x 13mm(L)	QSD513
•	•	Quad Shaping Drill, 5mm(D) x 15mm(L)	QSD515
•	•	Quad Shaping Drill, 6mm(D) x 8.5mm(L)	QSD685
•	•	Quad Shaping Drill, 6mm(D) x 10mm(L)	QSD610
•	•	Quad Shaping Drill, 6mm(D) x 11.5mm(L)	QSD611
•	•	Quad Shaping Drill, 6mm(D) x 13mm(L)	QSD613
•	•	Quad Shaping Drill, 6mm(D) x 15mm(L)	QSD615
•	•	Dense Bone Tap, 3.25mm(D) x 8.5mm(L)	NTAP3285
•	•	Dense Bone Tap, 3.25mm(D) x 10mm(L)	NTAP3210
•	•	Dense Bone Tap, 3.25mm(D) x 11.5mm(L)	NTAP3211
•	•	Dense Bone Tap, 3.25mm(D) x 13mm(L)	NTAP3213
•	•	Dense Bone Tap, 3.25mm(D) x 15mm(L)	NTAP3215
•	•	Dense Bone Tap, 4mm(D) x 8.5mm(L)	NTAP485
•	•	Dense Bone Tap, 4mm(D) x 10mm(L)	NTAP410
•	•	Dense Bone Tap, 4mm(D) x 11.5mm(L)	NTAP411
•	•	Dense Bone Tap, 4mm(D) x 13mm(L)	NTAP413
•	•	Dense Bone Tap, 4mm(D) x 15mm(L)	NTAP415
•	•	Dense Bone Tap, 5mm(D) x 8.5mm(L)	NTAP585
•	•	Dense Bone Tap, 5mm(D) x 10mm(L)	NTAP510

Some products may not be available outside of the United States.
 Algunos productos no se comercializan fuera de EE.UU.
 Certains produits ne sont pas disponibles en dehors des États-Unis.
 Einige Produkte sind außerhalb der USA nicht erhältlich.

Site Preparation Technologies



Tapered Surgical Kits Cont'd

 QNTSK40 Premium Kit	 QNTSK40U Upgrade Kit	<i>Description</i>	<i>Item Numbers</i>
•	•	Dense Bone Tap, 5mm(D) x 11.5mm(L)	NTAP511
•	•	Dense Bone Tap, 5mm(D) x 13mm(L)	NTAP513
•	•	Dense Bone Tap, 5mm(D) x 15mm(L)	NTAP515
•	•	Dense Bone Tap, 6mm(D) x 8.5mm(L)	NTAP685
•	•	Dense Bone Tap, 6mm(D) x 10mm(L)	NTAP610
•	•	Dense Bone Tap, 6mm(D) x 11.5mm(L)	NTAP611
•	•	Dense Bone Tap, 6mm(D) x 13mm(L)	NTAP613
•	•	Dense Bone Tap, 6mm(D) x 15mm(L)	NTAP615
•	•	Tapered Implant Depth Indicator, 3.25mm(D) x 8.5mm(L) 3ea.	NTDI3285
•	•	Tapered Implant Depth Indicator, 3.25mm(D) x 10mm(L)	NTDI3210
•	•	Tapered Implant Depth Indicator, 3.25mm(D) x 11.5mm(L)	NTDI3211
•	•	Tapered Implant Depth Indicator, 3.25mm(D) x 13mm(L)	NTDI3213
•	•	Tapered Implant Depth Indicator, 3.25mm(D) x 15mm(L)	NTDI3215
•	•	Tapered Implant Depth Indicator, 4mm(D) x 8.5mm(L) 3ea.	NTDI485
•	•	Tapered Implant Depth Indicator, 4mm(D) x 10mm(L)	NTDI410
•	•	Tapered Implant Depth Indicator, 4mm(D) x 11.5mm(L)	NTDI411
•	•	Tapered Implant Depth Indicator, 4mm(D) x 13mm(L)	NTDI413
•	•	Tapered Implant Depth Indicator, 4mm(D) x 15mm(L)	NTDI415
•	•	Tapered Implant Depth Indicator, 5mm(D) x 8.5mm(L) 3ea.	NTDI585
•	•	Tapered Implant Depth Indicator, 5mm(D) x 10mm(L)	NTDI510
•	•	Tapered Implant Depth Indicator, 5mm(D) x 11.5mm(L)	NTDI511
•	•	Tapered Implant Depth Indicator, 5mm(D) x 13mm(L)	NTDI513
•	•	Tapered Implant Depth Indicator, 5mm(D) x 15mm(L)	NTDI515
•	•	Tapered Implant Depth Indicator, 6mm(D) x 8.5mm(L) 3ea.	NTDI685
•	•	Tapered Implant Depth Indicator, 6mm(D) x 10mm(L)	NTDI610
•	•	Tapered Implant Depth Indicator, 6mm(D) x 11.5mm(L)	NTDI611
•	•	Tapered Implant Depth Indicator, 6mm(D) x 13mm(L)	NTDI613
•	•	Tapered Implant Depth Indicator, 6mm(D) x 15mm(L)	NTDI615
•	•	Certain® Countersink Drill, PREVAIL® 3/4/3mm(P)	ICD100
•	•	Plastic Insert For Tray	QNTSKI
•	•	QSD/NTDI Surgical Tray	QNTSKT
•	•	Open End Wrench	CW100
•	•	Ratchet Wrench	WR150
•	•	Ratchet Extension (Short), 6mm(L)	RE100
•	•	Ratchet Extension (Long), 15mm(L)	RE200

Some products may not be available outside of the United States.
 Algunos productos no se comercializan fuera de EE.UU.
 Certains produits ne sont pas disponibles en dehors des États-Unis.
 Einige Produkte sind außerhalb der USA nicht erhältlich.

Site Preparation Technologies

Tapered Surgical Kits Cont'd

 QNTSK40 Premium Kit	 QNTSK40U Upgrade Kit	<i>Description</i>	<i>Item Numbers</i>
•		Implant Depth Gauge, 20mm(L)	DP020
•		Narrow Posterior Hexed Driver, 17mm(L)	PHD00N
•		Posterior Large Hexed Driver, 17mm(L)	PHD02N
•		Narrow Right Angle Large Hexed Driver Tip, 24mm	RASH3N
•		Drill Extension	ACTDE
•		Direction Indicator, 2mm(D) x 10mm(L) 3ea.	DI100
•		Handpiece Connector	MDR10
•		Implant Mount, 3.4mm(D) x 15mm(L)	MMC15
•		ACT® Pointed Starter Drill	ACTPSD
•		ACT Reusable Twist Drill, 2mm(D) x 10mm(L)	ACT2010
•		ACT Reusable Twist Drill, 2mm(D) x 15mm(L)	ACT2015
•		ACT Reusable Twist Drill, 2mm(D) x 20mm(L)	ACT2020
•		Certain® Implant Placement Driver Tip (Short),	IIPDTS
•		Certain Placement Driver Tip (Short), 3.4mm(D)	IMPDTS
•		Certain Implant Placement Driver Tip (Long)	IIPDTL
•		Certain Implant Placement Driver Tip (Long), 3.4mm(D)	IMPDTL
•		Certain Ratchet Extension (Short), 6mm(L)	IMRE100
•		Certain Ratchet Extension (Long), 15mm(L)	IMRE200
•		Certain Ratchet Extension Driver, 6mm(L)	IRE100
•		Certain Ratchet Extension Driver, 15mm(L)	IRE200
•		Certain Driver Replacement O-Rings (10-Pack)	IRORDR



Some products may not be available outside of the United States.
 Algunos productos no se comercializan fuera de EE.UU.
 Certains produits ne sont pas disponibles en dehors des États-Unis.
 Einige Produkte sind außerhalb der USA nicht erhältlich.

Site Preparation Technologies

Parallel Walled Surgical Kits

PSKT40 Premium Kit





 PSKT01 Starter Kit	 PSKT35 Certain® Premium Kit	 PSKT40 Premium Kit	Description	Item Numbers
•	•	•	Plastic UniSystem Surgical Tray	PTT300I
•	•	•	Narrow Large Hex Driver, Tip 24mm	RASH3N
•	•	•	Handpiece Connector	MDR10
•		•	Narrow Small Hex Hand Driver, 17mm(L)	PHD00N
•	•	•	Narrow Large Hex Hand Driver, 17mm(L)	PHD02N
•		•	Open End Wrench	CW100
•	•	•	Ratchet Wrench	WR150
•		•	Ratchet Extension (Short), 6mm(L)	RE100
•	•	•	Ratchet Extension (Long), 15mm(L)	RE200
•	•	•	Implant Depth Gauge	DP020
•		•	Implant Mount, 3.4mm(D) x 15mm(L)	MMC15
	•	•	Bone Tap, 4mm(D) x 13mm(L)	TAP413
	•	•	Bone Tap, 3.25mm(D) x 18mm(L)	MTAP2
•	•	•	Direction Indicator, 2mm(D) x 10mm(L) 3ea.	DI100
•	•	•	Stainless Steel Round Drill	RD100
	•	•	ACT® Reusable Twist Drill, 2mm(D) x 10mm(L)	ACT2010
•	•	•	ACT Reusable Twist Drill, 2mm(D) x 15mm(L)	ACT2015
	•	•	ACT Reusable Twist Drill, 2mm(D) x 20mm(L)	ACT2020
	•	•	ACT Reusable Twist Drill, 2.75mm(D) x 10mm(L)	ACT2710
•	•	•	ACT Reusable Twist Drill, 2.75mm(D) x 15mm(L)	ACT2715
		•	ACT Reusable Twist Drill, 2.75mm(D) x 20mm(L)	ACT2720
	•	•	ACT Reusable Twist Drill, 3mm(D) x 10mm(L)	ACT3010
•	•	•	ACT Reusable Twist Drill, 3mm(D) x 15mm(L)	ACT3015
		•	ACT Reusable Twist Drill, 3mm(D) x 20mm(L)	ACT3020
	•	•	ACT Reusable Twist Drill, 3.25mm(D) x 10mm(L)	ACT3210
•	•	•	ACT Reusable Twist Drill, 3.25mm(D) x 15mm(L)	ACT3215
		•	ACT Reusable Twist Drill, 3.25mm(D) x 20mm(L)	ACT3220
•	•	•	Pilot Drill, 2-3mm(D)	PD100
•		•	Countersink Drill	CD100
•	•	•	Drill Extension	ACTDE
		•	Plastic Organizer Tray	PTT100

Some products may not be available outside of the United States.
 Algunos productos no se comercializan fuera de EE.UU.
 Certains produits ne sont pas disponibles en dehors des États-Unis.
 Einige Produkte sind außerhalb der USA nicht erhältlich.

Site Preparation Technologies





Parallel Walled Surgical Kits Cont'd

 PSKT01 Starter Kit	 PSKT35 Certain® Premium Kit	 PSKT40 Premium Kit	<i>Description</i>	<i>Item Numbers</i>
	•	•	ACT® Reusable Twist Drill, 4.25mm(D) x 8.5mm(L)	ACT4285
•	•	•	ACT Reusable Twist Drill, 4.25mm(D) x 13mm(L)	ACT4213
	•	•	ACT Reusable Twist Drill, 4.25mm(D) x 18mm(L)	ACT4218
	•	•	ACT Reusable Twist Drill, 5.25mm(D) x 8.5mm(L)	ACT5285
	•	•	ACT Reusable Twist Drill, 5.25mm(D) x 13mm(L)	ACT5213
	•	•	ACT Reusable Twist Drill, 5.25mm(D) x 18mm(L)	ACT5218
	•	•	Countersink Drill, OSSEOTITE XP® 4/5mm, PREVAIL® 4/5/4	CD4500
•	•	•	Pilot/Countersink Drill 5mm(D)	CD500
	•	•	Countersink Drill, OSSEOTITE XP 5/6mm, PREVAIL 5/6/5	CD5600
	•	•	Pilot/Countersink Drill, 6mm(D)	CD600
	•	•	Tap, 5mm(D) x 13mm(L)	TAP53S
	•	•	Tap, 6mm(D) x 13mm(L)	TAP63S
	•	•	Certain Implant Driver Tip (Short), 3.4mm(D)	IMPDTS
•	•	•	Certain Implant Driver Tip (Long), 3.4mm(D)	IMPDTL
	•	•	Certain Ratchet Extension (Short), 6mm(L)	IMRE100
•	•	•	Certain Ratchet Extension (Long), 15mm(L)	IMRE200
•	•	•	Certain Implant Placement Driver Tip (Short)	IIPDTS
•	•	•	Certain Implant Placement Driver Tip (Long)	IIPDTL
•	•	•	Certain Ratchet Extension Driver, 6mm(L)	IRE100
•	•	•	Certain Ratchet Extension Driver, 15mm(L)	IRE200
•	•	•	Certain Countersink Drill, PREVAIL 3/4/3mm(P)	ICD100
	•	•	Driver Tip Replacement O-Rings, 10-Pack	IRORDR

Some products may not be available outside of the United States.
 Algunos productos no se comercializan fuera de EE.UU.
 Certains produits ne sont pas disponibles en dehors des États-Unis.
 Einige Produkte sind außerhalb der USA nicht erhältlich.

Site Preparation Technologies





Parallel Walled Surgical Kits

 PSKT10 Basic Kit	 PSKT20 Standard Kit	 PSKT30 Premium Kit	 PSKT30U Upgrade Kit	Description	Item Numbers
•	•	•		Plastic UniSystem Surgical Tray	PTT300I
•	•	•		Narrow Large Hex Driver Tip, 24mm	RASH3N
•	•	•		Handpiece Connector	MDR10
•	•	•		Narrow Small Hex Hand Driver, 17mm(L)	PHD00N
•	•	•		Narrow Large Hex Hand Driver, 17mm(L)	PHD02N
•	•	•		Open End Wrench	CW100
•	•	•		Ratchet Wrench	WR150
•	•	•		Ratchet Extension (Short), 6mm(L)	RE100
•	•	•		Ratchet Extension (Long), 15mm(L)	RE200
•	•	•		Implant Depth Gauge	DP020
	•	•		Implant Mount, 3.4mm(D) x 15mm(L)	MMC15
	•	•		Bone Tap, 4mm(D) x 13mm(L)	TAP413
	•	•		Bone Tap, 3.25mm(D) x 18mm(L)	MTAP2
	•	•		Direction Indicator, 2mm(D) x 10mm(L) 3ea.	DI100
	•	•		Stainless Steel Round Drill	RD100
	•	•		ACT® Reusable Twist Drill, 2mm(D) x 10mm(L)	ACT2010
	•	•		ACT Reusable Twist Drill, 2mm(D) x 15mm(L)	ACT2015
	•	•		ACT Reusable Twist Drill, 2mm(D) x 20mm(L)	ACT2020
	•	•		ACT Reusable Twist Drill, 2.75mm(D) x 10mm(L)	ACT2710
	•	•		ACT Reusable Twist Drill, 2.75mm(D) x 15mm(L)	ACT2715
	•	•		ACT Reusable Twist Drill, 2.75mm(D) x 20mm(L)	ACT2720
	•	•		ACT Reusable Twist Drill, 3mm(D) x 10mm(L)	ACT3010
	•	•		ACT Reusable Twist Drill, 3mm(D) x 15mm(L)	ACT3015
	•	•		ACT Reusable Twist Drill, 3mm(D) x 20mm(L)	ACT3020
	•	•		ACT Reusable Twist Drill, 3.25mm(D) x 10mm(L)	ACT3210
	•	•		ACT Reusable Twist Drill, 3.25mm(D) x 15mm(L)	ACT3215
	•	•		ACT Reusable Twist Drill, 3.25mm(D) x 20mm(L)	ACT3220
	•	•		Pilot Drill, 2-3mm(D)	PD100
	•	•		Countersink Drill	CD100
	•	•		Drill Extension	ACTDE
	•	•		Plastic Organizer Tray	PTT100
		•		ACT Reusable Twist Drill, 4.25mm(D) x 8.5mm(L)	ACT4285
		•		ACT Reusable Twist Drill, 4.25mm(D) x 13mm(L)	ACT4213
		•		ACT Reusable Twist Drill, 4.25mm(D) x 18mm(L)	ACT4218
		•		ACT Reusable Twist Drill, 5.25mm(D) x 8.5mm(L)	ACT5285
		•		ACT Reusable Twist Drill, 5.25mm(D) x 13mm(L)	ACT5213
		•		ACT Reusable Twist Drill, 5.25mm(D) x 18mm(L)	ACT5218

Some products may not be available outside of the United States.
 Algunos productos no se comercializan fuera de EE.UU.
 Certains produits ne sont pas disponibles en dehors des États-Unis.
 Einige Produkte sind außerhalb der USA nicht erhältlich.

Site Preparation Technologies

Parallel Walled Surgical Kits Cont'd

 PSKT10 Basic Kit	 PSKT20 Standard Kit	 PSKT30 Premium Kit	 PSKT30U Upgrade Kit	Description	Item Numbers
		•		Countersink Drill, OSSEOTITE XP®, 4/5mm, PREVAIL® 4/5/4	CD4500
		•		Pilot/Countersink Drill, 5mm(D)	CD500
		•		Countersink Drill, OSSEOTITE XP 5/6mm, PREVAIL 5/6/5	CD5600
		•		Pilot/Countersink Drill, 6mm(D)	CD600
		•		Tap, 5mm(D) x 13mm(L)	TAP53S
		•		Tap, 6mm(D) x 13mm(L)	TAP63S
			•	Plastic Insert for Tray	PTT300UI
			•	Certain® Implant Driver Tip (Short), 3.4mm(D)	IMPDTS
			•	Certain Implant Driver Tip (Long), 3.4mm(D)	IMPDTL
			•	Certain Ratchet Extension (Short), 6mm(L)	IMRE100
			•	Certain Ratchet Extension (Long), 15mm(L)	IMRE200
			•	Certain Implant Placement Driver Tip (Short)	IIPDTS
			•	Certain Implant Placement Driver Tip (Long)	IIPDTL
			•	Certain Ratchet Extension Driver, 6mm(L)	IRE100
			•	Certain Ratchet Extension Driver, 15mm(L)	IRE200
			•	Certain Countersink Drill, PREVAIL 3/4/3mm(P)	ICD100
			•	Driver Tip Replacement O-Rings, 10-Pack	IRORDR

PTT100 Plastic Tray Organizer

NOTE: For use with PTT300I



Some products may not be available outside of the United States.
 Algunos productos no se comercializan fuera de EE.UU.
 Certains produits ne sont pas disponibles en dehors des États-Unis.
 Einige Produkte sind außerhalb der USA nicht erhältlich.

Site Preparation Technologies

Reusable Twist Drills

ACT® Non-Irrigated Twist Drills

Implant Lengths	Drill Lengths	2.0mm(D)	2.3mm(D)	2.75mm(D)	3.0mm(D)	3.15mm(D)	3.25mm(D)	3.85mm(D)	4.25mm(D)	4.85mm(D)	5.25mm(D)
7-8.5mm	8.5mm	N/A	N/A	N/A	N/A	N/A	N/A	N/A	ACT4285	ACT4885	ACT5285
7-10.0mm	10.0mm	ACT2010	N/A	ACT2710	ACT3010	ACT3110	ACT3210	ACT3810	N/A	N/A	N/A
7-13.0mm	13.0mm	N/A	N/A	N/A	N/A	N/A	N/A	N/A	ACT4213	ACT4813	ACT5213
7-15.0mm	15.0mm	ACT2015	N/A	ACT2715	ACT3015	ACT3115	ACT3215	ACT3815	N/A	N/A	N/A
7-18.0mm	18.0mm	N/A	N/A	N/A	N/A	N/A	N/A	N/A	ACT4218	ACT4818	ACT5218
7-20.0mm	20.0mm	ACT2020	N/A	ACT2720	ACT3020	ACT3120	ACT3220	ACT3820	N/A	N/A	N/A



Irrigated, Hubbed Twist Drills

7-8.5mm	8.5mm	N/A	N/A	N/A	N/A	N/A	N/A	N/A	ITD428	N/A	ITD528
7-10.0mm	10.0mm	N/A	ITD210	ITD2710	ITD310	ITD3110	ITD3210	N/A	N/A	N/A	N/A
7-13.0mm	13.0mm	N/A	N/A	N/A	N/A	N/A	N/A	N/A	ITD423	N/A	ITD523
7-15.0mm	15.0mm	N/A	ITD215	ITD2715	ITD315	ITD3115	ITD3215	N/A	N/A	N/A	N/A
7-18.0mm	18.0mm	N/A	N/A	N/A	N/A	N/A	N/A	N/A	ITD4218	N/A	ITD5218
7-20.0mm	20.0mm	N/A	ITD220	ITD2720	ITD320	ITD3120	ITD3220	N/A	N/A	N/A	N/A



Disposable Twist Drills

Non-Irrigated, Hubbed Twist Drills

Implant Lengths	Drill Lengths	2.0mm(D)	2.3mm(D)	2.75mm(D)	3.0mm(D)	3.15mm(D)	3.25mm(D)	3.85mm(D)	4.25mm(D)	4.85mm(D)	5.25mm(D)
7-8.5mm	8.5mm	N/A	N/A	N/A	N/A	N/A	N/A	N/A	DT428	N/A	DT528
7-10.0mm	10.0mm	DT2010	DT210	DT2710	DT310	DT3110	DT3210	N/A	N/A	N/A	N/A
7-13.0mm	13.0mm	N/A	N/A	N/A	N/A	N/A	N/A	N/A	DT423	N/A	DT523
7-15.0mm	15.0mm	DT2015	DT215	DT2715	DT315	DT3115	DT3215	N/A	N/A	N/A	N/A
7-18.0mm	18.0mm	N/A	N/A	N/A	N/A	N/A	N/A	N/A	DT4218	N/A	DT5218
7-20.0mm	20.0mm	DT2020	DT220	DT2720	DT320	DT3120	DT3220	N/A	N/A	N/A	N/A



Non-Irrigated, Non-Hubbed Twist Drills

7-8.5mm	8.5mm	N/A	N/A	N/A	N/A	N/A	N/A	N/A	DTN428	N/A	DTN528
7-10.0mm	10.0mm	DTN210	DTN2310	DTN2710	DTN310	DTN3110	DTN3210	N/A	N/A	N/A	N/A
7-13.0mm	13.0mm	N/A	N/A	N/A	N/A	N/A	N/A	N/A	DTN423	N/A	DTN523
7-15.0mm	15.0mm	DTN215	DTN2315	DTN2715	DTN315	DTN3115	DTN3215	N/A	N/A	N/A	N/A
7-18.0mm	18.0mm	N/A	N/A	N/A	N/A	N/A	N/A	N/A	DTN4218	N/A	DTN5218
7-20.0mm	20.0mm	DTN220	DTN2320	DTN2720	DTN320	DTN3120	DTN3220	N/A	N/A	N/A	N/A



Some products may not be available outside of the United States.
 Algunos productos no se comercializan fuera de EE.UU.
 Certains produits ne sont pas disponibles en dehors des États-Unis.
 Einige Produkte sind außerhalb der USA nicht erhältlich.

Site Preparation Technologies

Surgical Drills

Drills

Description	Disposable	Reusable
Round Bur	DR100	RD100
ACT® Pointed Starter Drill	N/A	ACTPSD
2/3mm Pilot Drill	DP100	PD100
4.1mm Countersink Drill - External Connection	DC100	CD100
4.1mm Countersink Drill - Certain® Connection	N/A	ICD100
4/5mm Countersink Drill	N/A	CD4500
5mm Pilot/Countersink Drill	DC500	CD500
5/6mm Countersink Drill	N/A	CD5600
6mm Pilot/Countersink Drill	DC600	CD600



Quad Shaping Drills For Tapered Implants



Drill Lengths	3.25mm (D)	4.0mm (D)	5.0mm (D)	6.0mm (D)
8.5mm	QSD3285	QSD485	QSD585	QSD685
10.0mm	QSD3210	QSD410	QSD510	QSD610
11.5mm	QSD3211	QSD411	QSD511	QSD611
13.0mm	QSD3213	QSD413	QSD513	QSD613
15.0mm	QSD3215	QSD415	QSD515	QSD615

Some products may not be available outside of the United States.
 Algunos productos no se comercializan fuera de EE.UU.
 Certains produits ne sont pas disponibles en dehors des États-Unis.
 Einige Produkte sind außerhalb der USA nicht erhältlich.

Site Preparation Technologies

Surgical Components

Drill Stops

Description	Item Numbers
2.3–3.25mm(D) x 10mm(L)	DS2310
2.3–3.25mm(D) x 15mm(L)	DS2315
2.3–3.25mm(D) x 20mm(L)	DS2320
4.25–5.25mm(D) x 8.5mm(L)	DS458
4.25–5.25mm(D) x 13mm(L)	DS4513
4.25–5.25mm(D) x 18mm(L)	DS4518
Drill Stop Block	DSB100

Bone Profilers

Description	Item Numbers
Kit Organizer Box	BB001
3.4mm(D) x 3.8mm(P)	BP340
Standard/OSSEOTITE XP® 3/4, 4.1mm(D) x 5mm(P)	BP450
Standard/OSSEOTITE XP 3/4, 4.1mm(D) x 6mm(P)	BP460
Standard/OSSEOTITE XP 3/4, 4.1mm(D) x 7.5mm(P)	BP475
5.0mm/OSSEOTITE XP 4/5, 5mm(D) x 5mm(P)	BP550
5.0mm/OSSEOTITE XP 4/5, 5mm(D) x 6mm(P)	BP560
5.0mm/OSSEOTITE XP 4/5, 5mm(D) x 7.5mm(P)	BP575
6.0mm/OSSEOTITE XP 5/6, 6mm(D) x 6mm(P)	BP660
6.0mm/OSSEOTITE XP 5/6, 6mm(D) x 7.5mm(P)	BP675
Bone Profiler Kit - For use with Standard 4.1mm(D) Implants Contains: BP450, BP460, BP475, BB001	BPKIT
Bone Profiler Kit - For use with 5mm(D) or 6mm(D) Implants Contains: BP550, BP560, BP575, BP660, BP675, BB001	BPAKT

All Bone Profiler Components and Kits listed above include External Connection Guide Pins. When using a Certain® Internal Connection Implant, please order the appropriate Certain Bone Profiler Guide Pin listed below.

Bone Profiler Guide Pin, Certain 3.25mm(D) 3pk	IBPMGP
Bone Profiler Guide Pin, Certain 4.1/5/6mm(D) 3pk	IBPGP
Guide for Bone Profile, 4.1, 5, 6mm(D)	BPGUIDE
Organizer Box For Standard Diameter Bone Profiler Kit	BPKITB
Organizer Box For Wide Diameter Bone Profiler Kit	BPAKTB
Certain Manual Bone Profiler, 3.4mm(D) x 4.1mm(P)	IMMBP
Certain Manual Bone Profiler, 4.1mm(D) x 5mm(P)	IMBP4
Certain Manual Bone Profiler, 5mm(D) x 6mm(P)	IMBP5



Some products may not be available outside of the United States.
 Algunos productos no se comercializan fuera de EE.UU.
 Certains produits ne sont pas disponibles en dehors des États-Unis.
 Einige Produkte sind außerhalb der USA nicht erhältlich.

Site Preparation Technologies

Surgical Components

Bone Taps



Implant Lengths	3.25mm (D)	3.75mm (D)	4.0mm (D)	5.0mm (D)	6.0mm (D)
8.5–18mm	MTAP1 (18mmL)	N/A	N/A	N/A	N/A
8.5–18mm	MTAP2 (27mmL)	N/A	N/A	N/A	N/A
7–10mm	N/A	TAP10	TAP410	N/A	N/A
7–13mm	N/A	TAP13	TAP413	N/A	N/A
7–20mm	N/A	TAP20	TAP420	N/A	N/A
7–8.5mm	N/A	N/A	N/A	TAP58S	TAP68S
7–13mm	N/A	N/A	N/A	TAP53S	TAP63S
7–18mm	N/A	N/A	N/A	TAP518S	TAP618S

Dense Bone Taps For Tapered Implants



Implant Lengths	3.25mm (D)	4.0mm (D)	5.0mm (D)	6.0mm (D)
8.5mm	NTAP3285	NTAP485	NTAP585	NTAP685
10.0mm	NTAP3210	NTAP410	NTAP510	NTAP610
11.5mm	NTAP3211	NTAP411	NTAP511	NTAP611
13.0mm	NTAP3213	NTAP413	NTAP513	NTAP613
15.0mm	NTAP3215	NTAP415	NTAP515	NTAP615

NTAPK Dense Bone Tap Kit

NOTE: Kit includes all of the Dense Bone Taps listed above.



Some products may not be available outside of the United States.
 Algunos productos no se comercializan fuera de EE.UU.
 Certains produits ne sont pas disponibles en dehors des États-Unis.
 Einige Produkte sind außerhalb der USA nicht erhältlich.

Site Preparation Technologies

Surgical Components

Depth/Direction Indicators For Tapered Implants



Implant Lengths	3.25mm (D)	4.0mm (D)	5.0mm (D)	6.0mm (D)
8.5mm	NTDI3285	NTDI485	NTDI585	NTDI685
10.0mm	NTDI3210	NTDI410	NTDI510	NTDI610
11.5mm	NTDI3211	NTDI411	NTDI511	NTDI611
13.0mm	NTDI3213	NTDI413	NTDI513	NTDI613
15.0mm	NTDI3215	NTDI415	NTDI515	NTDI615

NTDIK Depth/Direction Indicator Kit

NOTE: Kit includes all of the indicators listed above.

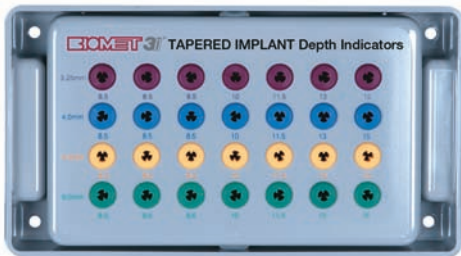

Some products may not be available outside of the United States.
 Algunos productos no se comercializan fuera de EE.UU.
 Certains produits ne sont pas disponibles en dehors des États-Unis.
 Einige Produkte sind außerhalb der USA nicht erhältlich.

Site Preparation Technologies

Surgical Components

Direction Indicators

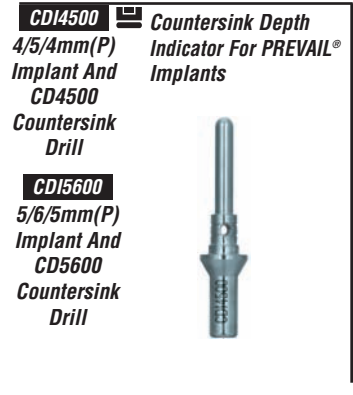
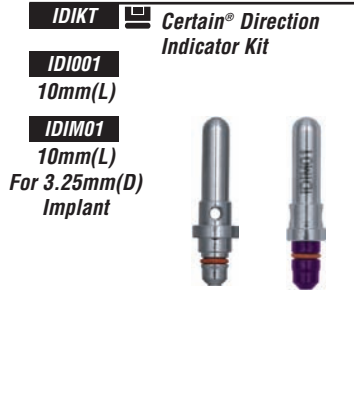
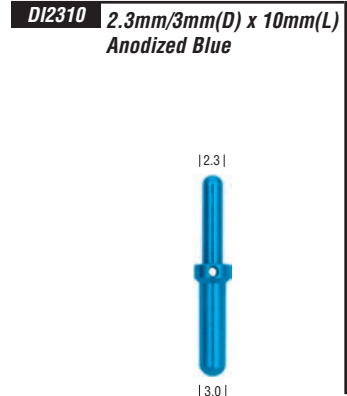
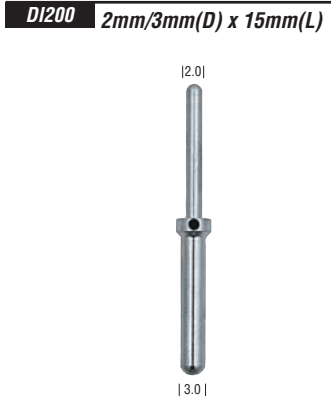
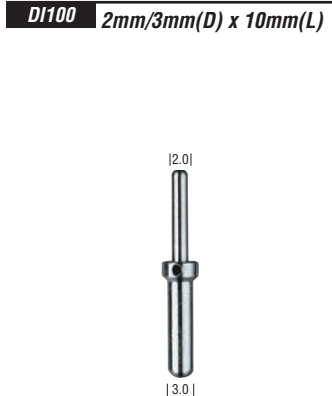

Mounts

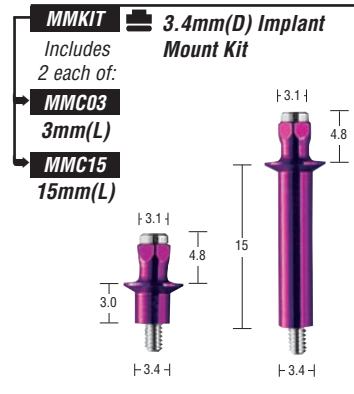
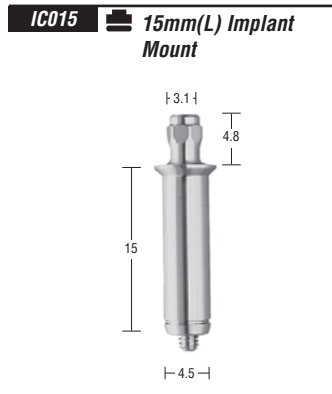

All indicated measurements are in millimeters.

Some products may not be available outside of the United States.
Algunos productos no se comercializan fuera de EE.UU.
Certains produits ne sont pas disponibles en dehors des États-Unis.
Einige Produkte sind außerhalb der USA nicht erhältlich.

Site Preparation Technologies

Surgical Components Radiographic Transparencies

ART1036 Certain® And External Connection Tapered Implants

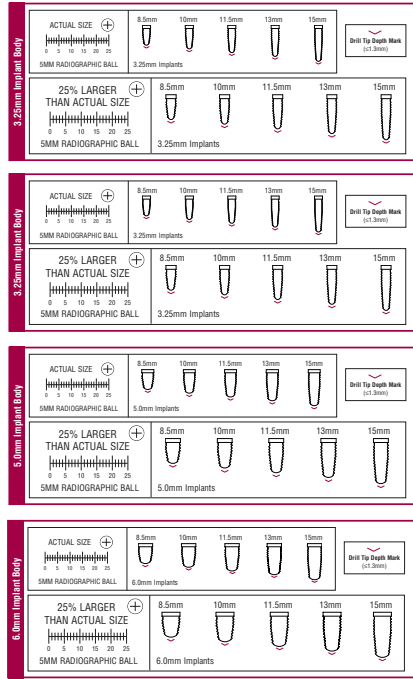

ART1037 Certain Parallel Walled And Straight Collar Certain PREVAIL Implants

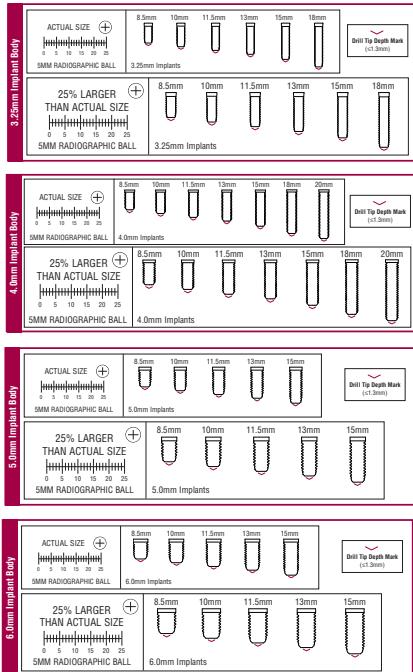

ART1025 Certain PREVAIL® Expanded Platform Implants OSSEOTITE XP® Certain Implants OSSEOTITE XP External Connection Implants

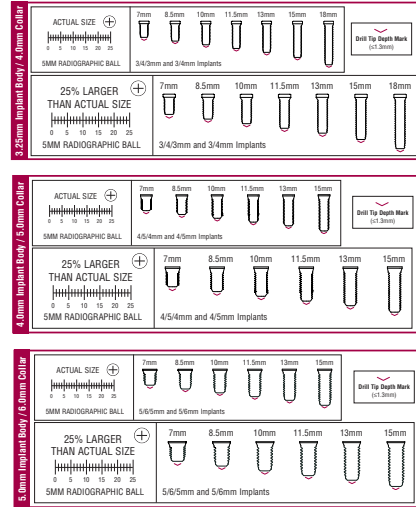

ART1027 External Connection Parallel Walled Implants

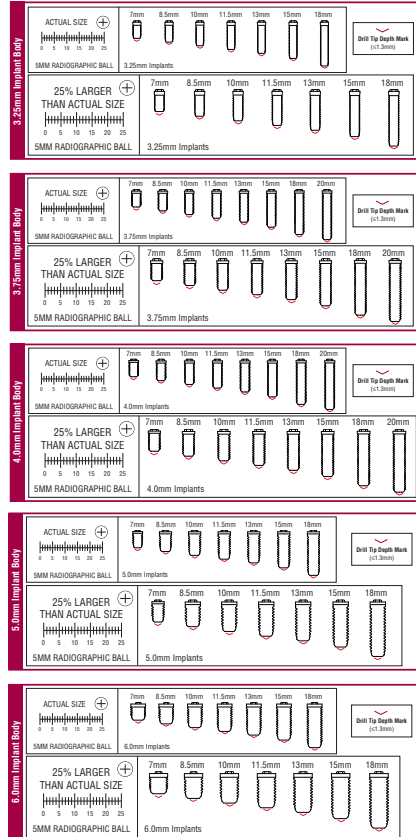

Some products may not be available outside of the United States.
Algunos productos no se comercializan fuera de EE.UU.
Certains produits ne sont pas disponibles en dehors des États-Unis.
Einige Produkte sind außerhalb der USA nicht erhältlich.

Site Preparation Technologies

Surgical Components

Miscellaneous Instrumentation

CW100 *Open End Wrench*

For use with External Connection and TG Implants.



TF002 *Titanium Forceps*



WR150 *Ratchet Wrench*



TE003 *Titanium Elevator*



TST01 *Titanium Suction Tip*



DPO20 *Implant Depth Gauge*



MALL1 *Mallet*

Stainless Steel



Some products may not be available outside of the United States.
Algunos productos no se comercializan fuera de EE.UU.
Certains produits ne sont pas disponibles en dehors des États-Unis.
Einige Produkte sind außerhalb der USA nicht erhältlich.

Site Preparation Technologies

Surgical Components

Miscellaneous Instrumentation

ACTDE Drill Extension



MDR10 Handpiece Connector



MIDTH Manual Interchangeable Driver Tip Handle



RMB30 Radiographic Marking Balls
5mm(D) (30-PK)



TMP80 Tissue Measuring Post

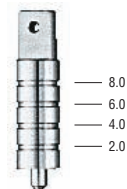

IC100 Surgical Index Coping



Some products may not be available outside of the United States.
Algunos productos no se comercializan fuera de EE.UU.
Certains produits ne sont pas disponibles en dehors des États-Unis.
Einige Produkte sind außerhalb der USA nicht erhältlich.

Site Preparation Technologies

Surgical Components

Miscellaneous Instrumentation

SGT25 **Stent Guide Tubes**
 2.39 x Stainless Steel (25-PK)
 10mm(L)





IIPDTL  **Certain® Implant Placement Driver Tip**
 Long

IIPDTS
 Short

IMPDTL
 3.4mm(D)
 Long

IMPDTS
 3.4mm(D)
 Short



IRORDR  **Certain Implant Driver Replacement O-Rings**
 (Qty: 10)



TP001 **Tissue Punch**
 4.1mm

TP005
 5mm

TP006
 6mm





XDG00 **Gelb Radiographic Depth Gauge Kit**
 Includes:

- XDG13**
 2mm(D)x13mm(L)
- XDG20**
 2mm(D)x20mm(L)
- XDG01**
 2.3mm(D)
 Includes:
- XDG2313**
 2.3mm(D)x13mm(L)
- XDG2320**
 2.3mm(D)x20mm(L)



Ratchet Extensions

		6mm(L)
IRE200	RE200	15mm(L)
IMRE100	N/A	6mm(L) x 3.4mm(D)
IMRE200	N/A	15mm(L) x 3.4mm(D)



Some products may not be available outside of the United States.
 Algunos productos no se comercializan fuera de EE.UU.
 Certains produits ne sont pas disponibles en dehors des États-Unis.
 Einige Produkte sind außerhalb der USA nicht erhältlich.

Site Preparation Technologies

Site Preparation Components

Straight And Angled Osteotomes

Description		Item Numbers
Straight OSSEOTITE® Tapered	Osteotome Kit	NTOST0
Angled OSSEOTITE Tapered	Osteotome Kit	NTOST0A
Straight OSSEOTITE Tapered 3.25mm(D)	Osteotome	NTOST3
Straight OSSEOTITE Tapered 4mm(D)	Osteotome	NTOST4
Straight OSSEOTITE Tapered 5mm(D)	Osteotome	NTOST5
Straight OSSEOTITE Tapered 6mm(D)	Osteotome	NTOST6
Angled OSSEOTITE Tapered 3.25mm(D)	Osteotome	NTOST3A
Angled OSSEOTITE Tapered 4mm(D)	Osteotome	NTOST4A
Angled OSSEOTITE Tapered 5mm(D)	Osteotome	NTOST5A
Angled OSSEOTITE Tapered 6mm(D)	Osteotome	NTOST6A
Straight OSSEOTITE Tapered Osteotome Tray		NTOSTTRS
Angled OSSEOTITE Tapered Osteotome Tray		NTOSTTRA



Summer Osteotomes

Description		Item Numbers
Summers Osteotome	Kit #1-4	OST00
Summers Osteotome	Kit #1-5	OST10
Summers Osteotome	Kit #1-5, FS	OST20
Summers Osteotome	#1	OST01
Summers Osteotome	#2	OST02
Summers Osteotome	#3	OST03
Summers Osteotome	#4	OST04
Summers Osteotome	#5	OST05
Summers Osteotome For Future Site		OSTFS
Summers Osteotome System Tray		OSTTR



Some products may not be available outside of the United States.
 Algunos productos no se comercializan fuera de EE.UU.
 Certains produits ne sont pas disponibles en dehors des États-Unis.
 Einige Produkte sind außerhalb der USA nicht erhältlich.

Site Preparation Technologies

Site Preparation Components

Sinus Elevation

Description	Item Numbers
Sinus Elevation Kit	SEKT1
Titanium Nitride Coated Bone Carrier	TIBC1
Small Membrane Elevator	ME100
Medium Membrane Elevator	ME200
Large Membrane Elevator	ME300
Large Titanium Plugger	TIPL1
Small Titanium Plugger	TIPS1
Sinus Elevation Tray	SEKTR



Trephine Burs

Description	Item Numbers
Trephine Bur, 2mm Inside Diameter/3mm Outside Diameter	TRE02
Trephine Bur, 4mm Inside Diameter/5mm Outside Diameter	TRE04
Trephine Bur, 5mm Inside Diameter/6mm Outside Diameter	TRE05
Trephine Bur, 6mm Inside Diameter/7mm Outside Diameter	TRE06
Trephine Bur, 8mm Inside Diameter/9.3mm Outside Diameter	TRE08

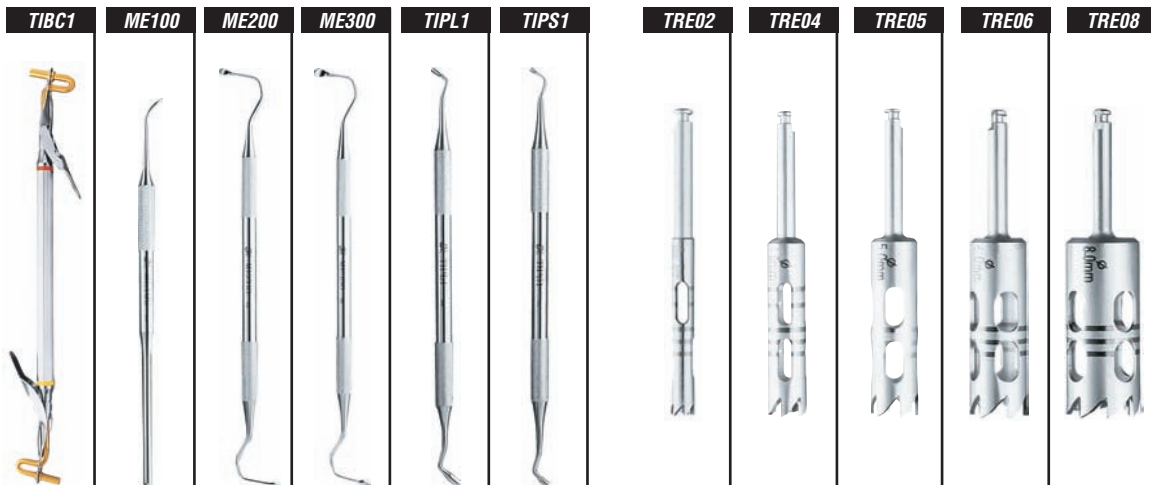

Sinus Elevators

Trephine Burs

Some products may not be available outside of the United States.
 Algunos productos no se comercializan fuera de EE.UU.
 Certains produits ne sont pas disponibles en dehors des États-Unis.
 Einige Produkte sind außerhalb der USA nicht erhältlich.

Regenerative Technologies

Product Overview



OsseoGuard® Resorbable Collagen Membrane

The protection you need to grow.

- Dental barrier for guided bone regeneration
- Type I collagen bovine source
- Strong enough to resist tearing when tacked or sutured, yet pliable for easy placement
- Resorption profile of 6-9 months
- Does not require removal when exposed

Manufactured By Collagen Matrix, Inc., Franklin Lakes, NJ



Endobon® Xenograft Granules

A RegenerOss® Product

- Bovine-derived Hydroxyapatite
- Osteoconductive material for bony in-growth
- 500–1000µm particle size for dental applications
- Interconnecting system of macro and micropores for stable integration

Manufactured By Biomet France Sarl

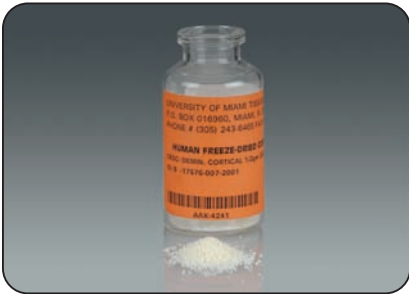

RegenerOss Allograft

The options you want. The results you expect. The safety you demand.

- Cortical or cancellous bone: mineralized or demineralized
- Three particle ranges: 200–300, 300–500, 500–800 microns
- Consistency from lot-to-lot
- Packaging is designed for ease of handling and quick, convenient reconstitution
- Donors are extensively screened and tested
- Aseptically processed

Manufactured By The University of Miami Tissue Bank

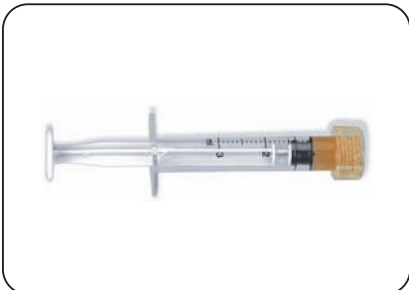

RegenerOss Allograft Putty

Demineralized Bone Matrix (DBM) in a lecithin carrier

- Contains 40% (by weight) DBM for optimal handling
- Osteoinductivity of every lot is validated by cell proliferation assay
- Moldable and resistant to irrigation for ease of use
- Provides graft containment for ease of delivery

Manufactured By Interpore Cross International

Regenerative Technologies

Product Overview



Biogran®

Bioactive glass for effective regeneration in most oral applications.

- Granules are the optimal size range, large enough not to pack too densely, small enough to fully resorb
- Provides a unique protective environment needed for osteogenesis
- Completely resorbable through the Krebs cycle
- 100% synthetic
- Forms a cohesive mass when mixed with blood or sterile saline, minimizing the potential for dry socket
- Pre-formed dappen dish or pre-formed dappen dish with empty syringe



Calcigen™ Oral

The strength you need for the stability you want.

- Medical-grade calcium sulfate (CaSO_4) in powder form
- Can be used as a barrier by itself or as a binder and stabilizer when mixed with graft materials
- Completely resorbable with no known side effects
- Packaged with a setting agent specifically for dental applications
- Easy to mix and apply

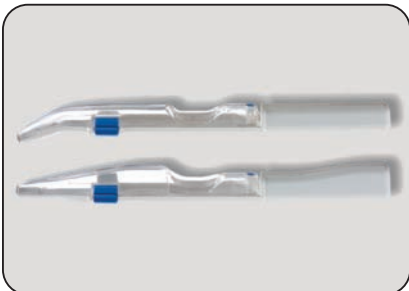

Safescraper® TWIST

Cortical bone scraper/collector

- Unique design provides 160° cutting area and facilitates access to difficult posterior regions
- Effectively harvests up to 5cc of bone
- Contains bone in a sterile exclusive chamber, which is designed to protect patients from cross-contamination
- Shortens operating time and simplifies graft collection
- Lateral opening system provides device stability

Manufactured By META® Advanced Medical Technology

Regenerative Technologies

Manufactured by:



Allografts

Description	Item Numbers		
RegenerOss® Allograft			
Deminerzalized Freeze Dried Bone Allograft (DFDBA) & Freeze Dried Bone Allograft (FDBA)			
Mineralized Cancellous	1/2gm	200–300µm	0344
Mineralized Cancellous	1/2gm	300–500µm	1449
Mineralized Cancellous	1/2gm	500–800µm	0411
Mineralized Cortical	1/2gm	200–300µm	0605
Mineralized Cortical	1/2gm	300–500µm	1450
Mineralized Cortical	1/2gm	500–800µm	0393
Deminerzalized Cancellous	1/2gm	200–300µm	1451
Deminerzalized Cancellous	1/2gm	300–500µm	1452
Deminerzalized Cancellous	1/2gm	500–800µm	0400
Deminerzalized Cortical	1/2gm	200–300µm	0338
Deminerzalized Cortical	1/2gm	300–500µm	1453
Deminerzalized Cortical	1/2gm	500–800µm	0394
Mineralized Cancellous	1gm	200–300µm	1563*
Mineralized Cancellous	1gm	300–500µm	1541*
Mineralized Cancellous	1gm	500–800µm	1354*
Mineralized Cancellous	4gm	300–500µm	1487*
Mineralized Cortical	1gm	300–500µm	1526*
Mineralized Cortical	1gm	500–800µm	1540*
Mineralized Cortical	4gm	500–800µm	1573*
Deminerzalized Cortical	4gm	500–800µm	0669*
Dental Skin	10cm ²		0078*
Dental Skin	20cm ²		0079*
Dura Mater-Patch (Membrane)	4x5cm		0655*
Fascia Lata Patch (Membrane)	4x5cm		0716*
Left Hemi Mandible			0631*
Mandible			0632*
Right Hemi Mandible			0630*
Iliac Crest Strip	Small		0055*
Iliac Crest Strip	Medium		0473*
Iliac Crest Strip	Large		0056*
Mineralized Cancellous Powder	10cc	100–200µm	1454*
Deminerzalized Cancellous Powder	10cc	100–200µm	1462*
Deminerzalized Cortical Powder	10cc	100–200µm	1465*
Dental M&M Block	Small		1507*
Dental M&M Block	Small Irradiated		1523*
Dental M&M Block	Medium		1491*
Dental M&M Block	Medium Irradiated		1522*
Dental M&M Block	Large		1508*
Dental M&M Block	Large Irradiated		1565*



*Special order, allow 4–6 weeks.

Some products may not be available outside of the United States.
 Algunos productos no se comercializan fuera de EE.UU.
 Certains produits ne sont pas disponibles en dehors des États-Unis.
 Einige Produkte sind außerhalb der USA nicht erhältlich.

Regenerative Technologies

Allografts Cont'd

Description	Item Numbers
RegenerOss® Allograft Putty Demineralized Bone Matrix In A Lecithin Carrier 0.5cc Syringe 1.0cc Syringe 2.0cc Syringe Manufactured By Interpore Cross International	ROAP05 ROAP10 ROAP20



Xenografts

Description	Item Numbers
Endobon® Xenograft Granules A RegenerOss Product (Bovine-derived Hydroxyapatite particulate) 0.5ml Pack 1.0ml Pack 2.0ml Pack Manufactured By Biomet France Sarl	ROX05 ROX10 ROX20



GBR Barrier

Description	Item Numbers
OsseoGuard® Membrane 15mm x 20mm Resorbable Collagen Membrane 20mm x 30mm Resorbable Collagen Membrane 30mm x 40mm Resorbable Collagen Membrane Manufactured By Collagen Matrix, Inc., Franklin Lakes, NJ	OG1520 OG2030 OG3040

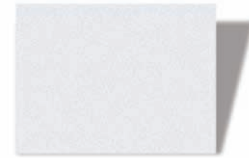

Alloplasts

Description	Item Numbers
Biogran® 100% Synthetic Resorbable Bone Graft Material Syringe and 750mg Cup Mixing Cups (500mg) Mixing Cups (750mg) Mixing Cups (1500mg)	1-Pack 2100-0750 7-Pack 2100-0003 7-Pack 2100-0004 7-Pack 2100-0005



Calcigen™ Oral Bone Graft System 100% Synthetic Resorbable Bone Graft Binder/Stabilizer 1.5gm Calcium Sulfate 0.8gm Setting Solution	CAL150
--	--------



Autogenous

Description	Item Numbers
Safescraper® TWIST Disposable Cortical Bone Collector (3-pack) Manufactured By META® Advanced Medical Technology	Curved 3987 Straight 3598



R. Quéting Bone-Mill Stainless Steel Bone Grinder Not available in all regions.	QBM001
--	--------



Some products may not be available outside of the United States.
 Algunos productos no se comercializan fuera de EE.UU.
 Certains produits ne sont pas disponibles en dehors des États-Unis.
 Einige Produkte sind außerhalb der USA nicht erhältlich.

Professional Development Products

Tools For The Art Of Business Building



BIOMET *3i* has a dedicated Professional Development Team and a comprehensive Practice Enhancement Portfolio. This portfolio includes tools for marketing, professional education and patient awareness education. Current available materials include (but are not limited to) the following:

<i>Description</i>	<i>Item Numbers</i>
BIOMET <i>3i</i> IDS™ “Creating & Driving Your Own Study Club” Guidebook	ART895
3x Model of GingiHue® Post 4mm(D) x 5mm(D) x 2mm(H) with Square Screw	APPGMOD1
3x Model of OSSEOTITE® Implant 4mm(D) x 13mm(L)	OSSMOD1
3x Model of OSSEOTITE Tapered Implant	NTMOD1
3x Model Set with OSSEOTITE Tapered Certain® Implant & GingiHue Post	INTMODSET
Patient Care Card (25pk)	ART930
Patient Ed Flip Chart (electronic version only)	ART943
Patient Ed Folio with DVD (electronic version only)	ART884
Patient Ed Brochure - Bone Loss (25pk)	ART885
Patient Ed Brochure - Single Tooth (25pk) (electronic version only)	ART886
Patient Ed Brochure - Multiple Teeth (25pk)	ART887
Patient Ed Brochure - Implant Retained, Bar (25pk)	ART890
Patient Ed Brochure - Implant Retained, Fixed (25pk)	ART888
Patient Ed Brochure - Implant Retained, LOCATOR® (25pk)	ART889
Patient Ed Brochure - Immediate Teeth Replacement, DIEM® (25pk)	ART929
Patient Ed Brochure - Spanish Version (Bone Loss)	ART957S
Patient Ed Brochure - Spanish Version (electronic version only)	ART958S
Patient Ed DVD - Multilingual Version	ART951EUR
Patient Ed Model - LOCATOR	PEMODLOC
Patient Ed Model - Single/Multiple Teeth	PEMODSM
Patient Ed Poster	ART962
Wrench for Tightening Model Screws	MODWRENCH



Some products may not be available outside of the United States.
 Algunos productos no se comercializan fuera de EE.UU.
 Certains produits ne sont pas disponibles en dehors des États-Unis.
 Einige Produkte sind außerhalb der USA nicht erhältlich.

Index

Cat.#	Description	Page#	Cat.#	Description	Page#
0055	ILLIAC CREST STRIP, SMALL	49	ACT2020	ACT REUSABLE TWIST DRILL, 2MM X 20MM	30,31,33,35
0056	ILLIAC CREST STRIP, LARGE	49	ACT2710	ACT REUSABLE TWIST DRILL, 2.75MM X 10MM	31,33,35
0078	DENTAL SKIN 10CM ²	49	ACT2715	ACT REUSABLE TWIST DRILL, 2.75MM X 15MM	31,33,35
0079	DENTAL SKIN 20CM ²	49	ACT2720	ACT REUSABLE TWIST DRILL, 2.75MM X 20MM	31,33,35
0338	DEMINERALIZED CORTICAL, 1/2GM, 200–300µm	49	ACT3010	ACT REUSABLE TWIST DRILL, 3MM X 10MM	31,33,35
0344	MINERALIZED CANCELLOUS, 1/2GM, 200–300µm	49	ACT3015	ACT REUSABLE TWIST DRILL, 3MM X 15MM	31,33,35
0393	MINERALIZED CORTICAL, 1/2GM, 500–800µm	49	ACT3020	ACT REUSABLE TWIST DRILL, 3MM X 20MM	31,33,35
0394	DEMINERALIZED CORTICAL, 1/2GM, 500–800µm	49	ACT3110	ACT REUSABLE TWIST DRILL, 3.15MM X 10MM	35
0400	DEMINERALIZED CANCELLOUS, 1/2GM, 500–800µm	49	ACT3115	ACT REUSABLE TWIST DRILL, 3.15MM X 15MM	35
0411	MINERALIZED CANCELLOUS, 1/2GM, 500–800µm	49	ACT3120	ACT REUSABLE TWIST DRILL, 3.15MM X 20MM	35
0473	ILLIAC CREST STRIP, MEDIUM	49	ACT3210	ACT REUSABLE TWIST DRILL, 3.25MM X 10MM	31,33,35
0605	MINERALIZED CORTICAL, 1/2GM, 200–300µm	49	ACT3215	ACT REUSABLE TWIST DRILL, 3.25MM X 15MM	31,33,35
0630	RIGHT HEMI MANDIBLE	49	ACT3220	ACT REUSABLE TWIST DRILL, 3.25MM X 20MM	31,33,35
0631	LEFT HEMI MANDIBLE	49	ACT3810	ACT REUSABLE TWIST DRILL, 3.85MM X 10MM	35
0632	MANDIBLE	49	ACT3815	ACT REUSABLE TWIST DRILL, 3.85MM X 15MM	35
0655	DURA MATER-PATCH (MEMBRANE), 4 X 5CM	49	ACT3820	ACT REUSABLE TWIST DRILL, 3.85MM X 20MM	35
0669	DEMINERALIZED CORTICAL, 4G, 500–800µm	49	ACT4213	ACT REUSABLE TWIST DRILL, 4.25MM X 13MM	32,33,35
0716	FASCIA LATA PATCH (MEMBRANE), 4 X 5CM	49	ACT4218	ACT REUSABLE TWIST DRILL, 4.25MM X 18MM	32,33,35
1354	MINERALIZED CANCELLOUS, 1GM, 500–800µm	49	ACT4285	ACT REUSABLE TWIST DRILL, 4.25MM X 8.5MM	32,33,35
1449	MINERALIZED CANCELLOUS, 1/2GM, 300–500µm	49	ACT4813	ACT REUSABLE TWIST DRILL, 4.85MM X 13MM	35
1450	MINERALIZED CORTICAL, 1/2GM, 300–500µm	49	ACT4818	ACT REUSABLE TWIST DRILL, 4.85MM X 18MM	35
1451	DEMINERALIZED CANCELLOUS, 1/2GM, 200–300µm	49	ACT4885	ACT REUSABLE TWIST DRILL, 4.85MM X 8.5MM	35
1452	DEMINERALIZED CANCELLOUS, 1/2GM, 300–500µm	49	ACT5213	ACT REUSABLE TWIST DRILL, 5.25MM X 13MM	32,33,35
1453	DEMINERALIZED CORTICAL, 1/2GM, 300–500µm	49	ACT5218	ACT REUSABLE TWIST DRILL, 5.25MM X 18MM	32,33,35
1454	MINERALIZED CANCELLOUS POWDER, 10CC, 100–200µm	49	ACT5285	ACT REUSABLE TWIST DRILL, 5.25MM X 8.5MM	32,33,35
1462	DEMINERALIZED CANCELLOUS POWDER, 10CC, 100–200µm	49	ACTDE	DRILL EXTENSION	30,31,33,43
1465	DEMINERALIZED CORTICAL POWDER, 10CC, 100–200µm	49	ACTPSD	ACT POINTED STARTER DRILL	30,36
1487	MINERALIZED CANCELLOUS, 4GM, 300–500µm	49	APPGMOD1	3X MODEL OF GINGIHUE® POST, 4MM(D) X 5MM(D) X 2MM(H) W/SCREW	51
1491	DENTAL M&M BLOCK, MEDIUM	49	ART884	PATIENT ED FOLIO WITH DVD (ELECTRONIC VERSION ONLY)	51
1507	DENTAL M&M BLOCK, SMALL	49	ART885	PATIENT ED BROCHURE - BONE LOSS (25PK)	51
1508	DENTAL M&M BLOCK, LARGE	49	ART886	PATIENT ED BROCHURE - SINGLE TOOTH (25PK) (ELECTRONIC VERSION)	51
1522	DENTAL M&M BLOCK, MEDIUM IRRADIATED	49	ART887	PATIENT ED BROCHURE - MULTIPLE TEETH (25PK)	51
1523	DENTAL M&M BLOCK, SMALL IRRADIATED	49	ART888	PATIENT ED BROCHURE - IMPLANT RETAINED, FIXED (25PK)	51
1526	MINERALIZED CORTICAL, 1GM, 300–500µm	49	ART889	PATIENT ED BROCHURE - IMPLANT RETAINED, LOCATOR® (25PK)	51
1540	MINERALIZED CORTICAL, 1GM, 500–800µm	49	ART890	PATIENT ED BROCHURE - IMPLANT RETAINED, BAR (25PK)	51
1541	MINERALIZED CANCELLOUS, 1GM, 300–500µm	49	ART895	BIOMET 3i IDS™ “CREATING & DRIVING YOUR OWN STUDY CLUB” GUIDEBOOK	51
1563	MINERALIZED CANCELLOUS, 1GM, 200–300µm	49	ART929	PATIENT ED BROCHURE - IMMEDIATE TEETH REPLACEMENT, DIEM® (25PK)	51
1565	DENTAL M&M BLOCK, LARGE IRRADIATED	49	ART930	PATIENT CARE CARD (25PK)	51
1573	MINERALIZED CORTICAL, 4GM, 500–800µm	49	ART943	PATIENT ED FLIP CHART (ELECTRONIC VERSION ONLY)	51
3598	SAFESCRAPER® TWIST STRAIGHT (3PK)	50	ART951EUR	PATIENT ED DVD - MULTILINGUAL VERSION	51
3987	SAFESCRAPER TWIST CURVED (3PK)	50	ART957S	PATIENT ED BROCHURE - SPANISH VERSION (BONE LOSS)	51
2100-0003	BIOGRAN® 500MG MIXING CUP (7PK)	50	ART958S	PATIENT ED BROCHURE - SPANISH (ELECTRONIC VERSION ONLY)	51
2100-0004	BIOGRAN 750MG MIXING CUP (7PK)	50	ART962	PATIENT ED POSTER	51
2100-0005	BIOGRAN 1500MG MIXING CUP (7PK)	50	ART1025	TRANSPARENCY FOR CERTAIN® PREVAIL® EXPANDED PLATFORM, OSSEOTITE XP® CERTAIN AND OSSEOTITE XP EXTERNAL CONNECTION IMPLANTS	41
2100-0750	BIOGRAN 750MG SYRINGE (1PK)	50	ART1027	TRANSPARENCY FOR EXTERNAL CONNECTION PARALLEL WALLED IMPLANTS	41
31-3100	BIOMET® 2MM FIXATION SYSTEM	27			
ACT2010	ACT® REUSABLE TWIST DRILL, 2MM X 10MM	30,31,33,35			
ACT2015	ACT REUSABLE TWIST DRILL, 2MM X 15MM	30,31,33,35			

Index

Cat.#	Description	Page#	Cat.#	Description	Page#
ART1036	TRANSPARENCY FOR CERTAIN® AND EXTERNAL CONNECTION TAPERED IMPLANTS	41	DDK3215	DISPOSABLE DRILL KIT W/DT3215	24
ART1037	TRANSPARENCY FOR PARALLEL WALLED AND STRAIGHT COLLAR CERTAIN PREVAIL® IMPLANTS	41	DDK3220	DISPOSABLE DRILL KIT W/DT3220	24
BB001	AUTOCLAVABLE ORGANIZER BOX	37	DDKN215	DISPOSABLE DRILL KIT W/DTN215	23
BP340	BONE PROFILER W/GUIDE PIN, 3.4MM(D) X 3.8MM(P)	37	DDKN2315	DISPOSABLE DRILL KIT W/DTN2315	23
BP450	BONE PROFILER W/GUIDE PIN, 4.1MM(D) X 5MM(P)	37	DDKN315	DISPOSABLE DRILL KIT W/DTN315	24
BP460	BONE PROFILER W/GUIDE PIN, 4.1MM(D) X 6MM(P)	37	DH100	DIRECTION INDICATOR, 2MM(D) X 10MM(L)	30,31,33,40
BP475	BONE PROFILER W/GUIDE PIN,, 4.1MM(D) X 7.5MM(P)	37	DI200	DIRECTION INDICATOR, 2MM(D) X 15MM(L)	40
BP550	BONE PROFILER W/GUIDE PIN, 5MM(D) X 5MM(P)	37	DI2310	DIRECTION INDICATOR, 2.3MM(D) X 10MM(L)	40
BP560	BONE PROFILER W/GUIDE PIN, 5MM(D) X 6MM(P)	37	DI2315	DIRECTION INDICATOR, 2.3MM(D) X 15MM(L)	40
BP575	BONE PROFILER W/GUIDE PIN, 5MM(D) X 7.5MM(P)	37	DP020	IMPLANT DEPTH GAUGE, 20MM(L)	30,31,33
BP660	BONE PROFILER W/GUIDE PIN, 6MM(D) X 6MM(P)	37	DP100	PILOT DISPOSABLE DRILL, 2/3MM	30,31,33
BP675	BONE PROFILER W/GUIDE PIN, 6MM(D) X 7.5MM(P)	37	DR100	DISPOSABLE ROUND BUR	30,31,33
BPAKT	WIDE DIAMETER BONE PROFILER KIT, 5MM & 6MM(D)	37	DS100J	OSSEOCISION® SURGICAL DRILL SYSTEM (100V) W/HANDPIECE	22
BPAKTB	ORGANIZER BOX FOR WIDE DIAMETER BONE PROFILERS	37	DS100RW	OSSEOCISION SURGICAL DRILL SYSTEM (230V) W/HANDPIECE	22
BPGUIDE	GUIDE FOR BONE PROFILER, 3.4, 4.1, 5, 6MM(D)	37	DS100US	OSSEOCISION SURGICAL DRILL SYSTEM (120V) W/HANDPIECE	22
BPKIT	STANDARD DIAMETER BONE PROFILER KIT, 4.1MM(D)	37	DS2310	DRILL STOP, 2.3MM-3.25MM X 10MM	37
BPKITB	ORGANIZER BOX FOR STANDARD DIAMETER BONE PROFILER KIT	37	DS2315	DRILL STOP, 2.3MM-3.25MM X 15MM	37
C202-750	TUBE CLAMP	22	DS2320	DRILL STOP, 2.3MM-3.25MM X 20MM	37
C293-025	INTERNAL IRRIGATION TUBE	22	DS4513	DRILL STOP, 4.25MM-5.25MM X 13MM	37
C823-752	Y-CONNECTOR	22	DS4518	DRILL STOP, 4.25MM-5.25MM X 18MM	37
CAL150	CALCIGEN™ ORAL - BONE GRAFT STABILIZER	50	DS458	DRILL STOP, 4.25MM-5.25MM X 8.5MM	37
CD100	COUNTERSINK REUSABLE DRILL, 4.1MM EXTERNAL CONNECTION	31,33,36	DSB100	DRILL STOP BLOCK	37
CD4500	COUNTERSINK REUSABLE DRILL, 4/5MM	32,34,36	DT2010	DISPOSABLE TWIST DRILL, 2MM(D) X 10MM(L)	35
CD500	PILOT/COUNTERSINK REUSABLE DRILL, 5MM	32,34,36	DT2015	DISPOSABLE TWIST DRILL, 2MM(D) X 15MM(L)	35
CD5600	PILOT/COUNTERSINK REUSABLE DRILL, 6MM	32,34,36	DT2020	DISPOSABLE TWIST DRILL, 2MM(D) X 20MM(L)	35
CD600	PILOT/COUNTERSINK REUSABLE DRILL, 4.25-5.25MM	32,34,36	DT210	DISPOSABLE TWIST DRILL, 2.3MM(D) X 10MM(L)	23,24,35
CDI4500	COUNTERSINK DEPTH INDICATOR FOR PREVAIL IMPLANTS, 4/5/4MM(P)	40	DT215	DISPOSABLE TWIST DRILL, 2.3MM(D) X 15MM(L)	23,24,35
CDI5600	COUNTERSINK DEPTH INDICATOR FOR PREVAIL IMPLANTS, 5/6/5MM(P)	40	DT220	DISPOSABLE TWIST DRILL, 2.3MM(D) X 20MM(L)	23,24,35
CS275	HEADLESS COVER SCREW, 4.1, 5, 6MM(D)	5,6,7,8	DT2710	DISPOSABLE TWIST DRILL, 2.75MM(D) X 10MM(L)	23,35
CS375	IMPLANT COVER SCREW, 4.1MM(D) X 1MM(H)	5,6,7,8	DT2715	DISPOSABLE TWIST DRILL, 2.75MM(D) X 15MM(L)	23,35
CS500	IMPLANT COVER SCREW, 5MM(D) X 1MM(H)	5,6,7,8	DT2720	DISPOSABLE TWIST DRILL, 2.75MM(D) X 20MM(L)	23,35
CS600	IMPLANT COVER SCREW, 6MM(D) X 1MM(H)	5,6,7,8	DT310	DISPOSABLE TWIST DRILL, 3MM(D) X 10MM(L)	24,35
CW100	OPEN END WRENCH	29,31,33,42	DT3110	DISPOSABLE TWIST DRILL, 3.15MM(D) X 10MM(L)	35
DC100	COUNTERSINK DISPOSABLE DRILL, 4.1MM EXT. CONNECTION	23,24,36	DT3115	DISPOSABLE TWIST DRILL, 3.15MM(D) X 15MM(L)	35
DC500	PILOT/COUNTERSINK DISPOSABLE DRILL, 5MM	36	DT3120	DISPOSABLE TWIST DRILL, 3.15MM(D) X 20MM(L)	35
DC600	PILOT/COUNTERSINK DISPOSABLE DRILL, 6MM	36	DT315	DISPOSABLE TWIST DRILL, 3MM(D) X 15MM(L)	24,35
DDK210	DISPOSABLE DRILL KIT W/DT210	23	DT320	DISPOSABLE TWIST DRILL, 3MM(D) X 20MM(L)	24,35
DDK215	DISPOSABLE DRILL KIT W/DT215	23	DT3210	DISPOSABLE TWIST DRILL, 3.25MM(D) X 10MM(L)	24,35
DDK220	DISPOSABLE DRILL KIT W/DT220	23	DT3215	DISPOSABLE TWIST DRILL, 3.25MM(D) X 15MM(L)	24,35
DDK2710	DISPOSABLE DRILL KIT W/DT2710	23	DT3220	DISPOSABLE TWIST DRILL, 3.25MM(D) X 20MM(L)	24,35
DDK2715	DISPOSABLE DRILL KIT W/DT2715	23	DT4218	DISPOSABLE TWIST DRILL, 4.25MM(D) X 18MM(L)	35
DDK2720	DISPOSABLE DRILL KIT W/DT2720	23	DT423	DISPOSABLE TWIST DRILL, 4.25MM(D) X 13MM(L)	35
DDK310	DISPOSABLE DRILL KIT W/DT310	24	DT428	DISPOSABLE TWIST DRILL, 4.25MM(D) X 8.5MM(L)	35
DDK315	DISPOSABLE DRILL KIT W/DT315	24	DT5218	DISPOSABLE TWIST DRILL, 5.25MM(D) X 18MM(L)	35
DDK320	DISPOSABLE DRILL KIT W/DT320	24	DT523	DISPOSABLE TWIST DRILL, 5.25MM(D) X 13MM(L)	35
DDK3210	DISPOSABLE DRILL KIT W/DT3210	24	DT528	DISPOSABLE TWIST DRILL, 5.25MM(D) X 8.5MM(L)	35
			DTN210	DISPOSABLE TWIST DRILL, NON-HUBBED, 2MM(D) X 10MM(L)	35
			DTN215	DISPOSABLE TWIST DRILL, NON HUBBED, 2MM(D) X 15MM(L)	23,24,35

Index

Cat.#	Description	Page#	Cat.#	Description	Page#
DTN220	DISPOSABLE TWIST DRILL, NON-HUBBED, 2MM(D) X 20MM(L)	35	EHA353	ENCODE 2-PC EP HEALING ABUTMENT, 3.4MM(P) X 5MM(P) X 3MM(H)	13
DTN2310	DISPOSABLE TWIST DRILL, NON-HUBBED, 2.3MM(D) X 10MM(L)	35	EHA354	ENCODE 2-PC EP HEALING ABUTMENT, 3.4MM(P) X 5MM(P) X 4MM(H)	13
DTN2315	DISPOSABLE TWIST DRILL, NON-HUBBED, 2.3MM(D) X 15MM(L)	23,35	EHA356	ENCODE 2-PC EP HEALING ABUTMENT, 3.4MM(P) X 5MM(P) X 6MM(H)	13
DTN2320	DISPOSABLE TWIST DRILL, NON-HUBBED, 2.3MM(D) X 20MM(L)	35	EHA358	ENCODE 2-PC EP HEALING ABUTMENT, 3.4MM(P) X 5MM(P) X 8MM(H)	13
DTN2710	DISPOSABLE TWIST DRILL, NON-HUBBED, 2.75MM(D) X 10MM(L)	35	EHA443	ENCODE 2-PC EP HEALING ABUTMENT, 4.1MM(D) X 4.1MM(P) X 3MM(H)	13
DTN2715	DISPOSABLE TWIST DRILL, NON-HUBBED, 2.75MM(D) X 15MM(L)	35	EHA444	ENCODE 2-PC EP HEALING ABUTMENT, 4.1MM(D) X 4.1MM(P) X 4MM(H)	13
DTN2720	DISPOSABLE TWIST DRILL, NON-HUBBED, 2.75MM(D) X 20MM(L)	35	EHA446	ENCODE 2-PC EP HEALING ABUTMENT, 4.1MM(D) X 4.1MM(P) X 6MM(H)	13
DTN310	DISPOSABLE TWIST DRILL, NON-HUBBED, 3MM(D) X 10MM(L)	35	EHA448	ENCODE 2-PC EP HEALING ABUTMENT, 4.1MM(D) X 4.1MM(P) X 8MM(H)	13
DTN3110	DISPOSABLE TWIST DRILL, NON-HUBBED, 3.15MM(D) X 10MM(L)	35	EHA453	ENCODE 2-PC EP HEALING ABUTMENT, 4.1MM(D) X 5MM(P) X 3MM(H)	13
DTN3115	DISPOSABLE TWIST DRILL, NON-HUBBED, 3.15MM(D) X 15MM(L)	35	EHA454	ENCODE 2-PC EP HEALING ABUTMENT, 4.1MM(D) X 5MM(P) X 4MM(H)	13
DTN3120	DISPOSABLE TWIST DRILL, NON-HUBBED, 3.15MM(D) X 20MM(L)	35	EHA456	ENCODE 2-PC EP HEALING ABUTMENT, 4.1MM(D) X 5MM(P) X 6MM(H)	13
DTN315	DISPOSABLE TWIST DRILL, NON-HUBBED, 3MM(D) X 15MM(L)	24,35	EHA458	ENCODE 2-PC EP HEALING ABUTMENT, 4.1MM(D) X 5MM(P) X 8MM(H)	13
DTN320	DISPOSABLE TWIST DRILL, NON-HUBBED, 3MM(D) X 20MM(L)	35	EHA463	ENCODE 2-PC EP HEALING ABUTMENT, 4.1MM(D) X 6MM(P) X 3MM(H)	13
DTN3210	DISPOSABLE TWIST DRILL, NON-HUBBED, 3.25MM(D) X 10MM(L)	35	EHA464	ENCODE 2-PC EP HEALING ABUTMENT, 4.1MM(D) X 6MM(P) X 4MM(H)	13
DTN3215	DISPOSABLE TWIST DRILL, NON-HUBBED, 3.25MM(D) X 15MM(L)	35	EHA466	ENCODE 2-PC EP HEALING ABUTMENT, 4.1MM(D) X 6MM(P) X 6MM(H)	13
DTN3220	DISPOSABLE TWIST DRILL, NON-HUBBED, 3.25MM(D) X 20MM(L)	35	EHA468	ENCODE 2-PC EP HEALING ABUTMENT, 4.1MM(D) X 6MM(P) X 8MM(H)	13
DTN4218	DISPOSABLE TWIST DRILL, NON-HUBBED, 4.25MM(D) X 18MM(L)	35	EHA473	ENCODE 2-PC EP HEALING ABUTMENT, 4.1MM(D) X 7.5MM(P) X 3MM(H)	13
DTN423	DISPOSABLE TWIST DRILL, NON-HUBBED, 4.25MM(D) X 13MM(L)	35	EHA474	ENCODE 2-PC EP HEALING ABUTMENT, 4.1MM(D) X 7.5MM(P) X 4MM(H)	13
DTN428	DISPOSABLE TWIST DRILL, NON-HUBBED, 4.25MM(D) X 8.5MM(L)	35	EHA476	ENCODE 2-PC EP HEALING ABUTMENT, 4.1MM(D) X 7.5MM(P) X 6MM(H)	13
DTN5218	DISPOSABLE TWIST DRILL, NON-HUBBED, 5.25MM(D) X 18MM(L)	35	EHA478	ENCODE 2-PC EP HEALING ABUTMENT, 4.1MM(D) X 7.5MM(P) X 8MM(H)	13
DTN523	DISPOSABLE TWIST DRILL, NON-HUBBED, 5.25MM(D) X 13MM(L)	35	EHA553	ENCODE 2-PC EP HEALING ABUTMENT, 5MM(D) X 5MM(P) X 3MM(H)	14
DTN528	DISPOSABLE TWIST DRILL, NON-HUBBED, 5.25MM(D) X 8.5MM(L)	35	EHA554	ENCODE 2-PC EP HEALING ABUTMENT, 5MM(D) X 5MM(P) X 4MM(H)	14
DU900EU	SURGICAL DRILL UNIT, 220V	21	EHA556	ENCODE 2-PC EP HEALING ABUTMENT, 5MM(D) X 5MM(P) X 6MM(H)	14
DU900US	SURGICAL DRILL UNIT, 110-130V	21	EHA558	ENCODE 2-PC EP HEALING ABUTMENT, 5MM(D) X 5MM(P) X 8MM(H)	14
DU9BG	BUR TESTING GAUGE	21,22	EHA563	ENCODE 2-PC EP HEALING ABUTMENT, 5MM(D) X 6MM(P) X 3MM(H)	14
DU9CH2	DU900 Y-CONNECTOR TUBES, 2 EA.	21	EHA564	ENCODE 2-PC EP HEALING ABUTMENT, 5MM(D) X 6MM(P) X 4MM(H)	14
DU9CL	DU900 IRRIG. TUBE CLAMPS, 5 EA.	21	EHA566	ENCODE 2-PC EP HEALING ABUTMENT, 5MM(D) X 6MM(P) X 6MM(H)	14
DU9CTC	DU900 INTERNAL IRRIG. TUBE, COMPLETE	21	EHA568	ENCODE 2-PC EP HEALING ABUTMENT, 5MM(D) X 6MM(P) X 8MM(H)	14
DU9F	DU900 CIRCUIT FUSE	21	EHA573	ENCODE 2-PC EP HEALING ABUTMENT, 5MM(D) X 7.5MM(P) X 3MM(H)	14
DU9FC	DU900 FOOT CONTROL, VARIABLE	21	EHA574	ENCODE 2-PC EP HEALING ABUTMENT, 5MM(D) X 7.5MM(P) X 4MM(H)	14
DU9IT	DU900 DISP. IRRIG. TUBING, 10 EA.	21	EHA576	ENCODE 2-PC EP HEALING ABUTMENT, 5MM(D) X 7.5MM(P) X 6MM(H)	14
DU9MC	DU900 MICROMOTOR WITH CORD	21	EHA578	ENCODE 2-PC EP HEALING ABUTMENT, 5MM(D) X 7.5MM(P) X 8MM(H)	14
DU9PCUS	DU900 POWER CORD. 110-130 VOLT USE	21	EHA663	ENCODE 2-PC EP HEALING ABUTMENT, 6MM(D) X 6MM(P) X 3MM(H)	14
DU9PCEU	DU900 POWER CORD. 220 VOLT USE	21	EHA664	ENCODE 2-PC EP HEALING ABUTMENT, 6MM(D) X 6MM(P) X 4MM(H)	14
DU9PT	DU900 PUMP TUBING, 85MM, 3 EA.	21	EHA666	ENCODE 2-PC EP HEALING ABUTMENT, 6MM(D) X 6MM(P) X 6MM(H)	14
DU9PTC	DU900 PUMP TUBING COMPLETE	21	EHA668	ENCODE 2-PC EP HEALING ABUTMENT, 6MM(D) X 6MM(P) X 8MM(H)	14
DU9SA	DU900 SPIKE ASSEMBLY WITH ROLLER CLAMP	21	EHA673	ENCODE 2-PC EP HEALING ABUTMENT, 6MM(D) X 7.5MM(P) X 3MM(H)	14
DU9SC	DU900 SPRAY CAP WITH NOZZLE	21	EHA674	ENCODE 2-PC EP HEALING ABUTMENT, 6MM(D) X 7.5MM(P) X 4MM(H)	14
DU9SP	DU900 STERILIZATION PROTECTOR	21	EHA676	ENCODE 2-PC EP HEALING ABUTMENT, 6MM(D) X 7.5MM(P) X 6MM(H)	14
DU9WS75	DU900 20:1 HANDPIECE	21	EHA678	ENCODE 2-PC EP HEALING ABUTMENT, 6MM(D) X 7.5MM(P) X 8MM(H)	14
DU9YC	DU900 Y-CONNECTOR	21	FNT3210	FULL OSSEOTITE® TAPERED IMPLANT, 3.25MM(D) X 10MM(L)	8
E211-001	MICROMOTOR WITH CORD FOR OSSEOCISION® SURGICAL DRILLING UNIT	22	FNT3211	FULL OSSEOTITE TAPERED IMPLANT, 3.25MM(D) X 11.5MM(L)	8
E211-051	MOTOR CORD FOR OSSEOCISION SURGICAL DRILLING UNIT	22	FNT3213	FULL OSSEOTITE TAPERED IMPLANT, 3.25MM(D) X 13MM(L)	8
E211-701	AUTOCLAVE PLUG FOR MOTOR	22	FNT3215	FULL OSSEOTITE TAPERED IMPLANT, 3.25MM(D) X 15MM(L)	8
EHA343	ENCODE® 2-PC EP® HEALING ABUTMENT, 3.4MM(D) X 3.8MM(P) X 3MM(H)	13	FNT3285	FULL OSSEOTITE TAPERED IMPLANT, 3.25MM(D) X 8.5MM(L)	8
EHA344	ENCODE 2-PC EP HEALING ABUTMENT, 3.4MM(D) X 3.8MM(P) X 4MM(H)	13	FNT410	FULL OSSEOTITE TAPERED IMPLANT, 4MM(D) X 10MM(L)	8
EHA346	ENCODE 2-PC EP HEALING ABUTMENT, 3.4MM(D) X 3.8MM(P) X 6MM(H)	13	FNT411	FULL OSSEOTITE TAPERED IMPLANT, 4MM(D) X 11.5MM(L)	8
EHA348	ENCODE 2-PC EP HEALING ABUTMENT, 3.4MM(D) X 3.8MM(P) X 8MM(H)	13	FNT413	FULL OSSEOTITE TAPERED IMPLANT, 4MM(D) X 13MM(L)	8

Index

Cat.#	Description	Page#	Cat.#	Description	Page#
FNT415	FULL OSSEOTITE® TAPERED IMPLANT, 4MM(D) X 15MM(L)	8	FOS607	FULL OSSEOTITE PARALLEL WALLED IMPLANT, 6MM(D) X 7MM(L)	6
FNT485	FULL OSSEOTITE TAPERED IMPLANT, 4MM(D) X 8.5MM(L)	8	FOS610	FULL OSSEOTITE PARALLEL WALLED IMPLANT, 6MM(D) X 10MM(L)	6
FNT510	FULL OSSEOTITE TAPERED IMPLANT, 5MM(D) X 10MM(L)	8	FOS611	FULL OSSEOTITE PARALLEL WALLED IMPLANT, 6MM(D) X 11.5MM(L)	6
FNT511	FULL OSSEOTITE TAPERED IMPLANT, 5MM(D) X 11.5MM(L)	8	FOS613	FULL OSSEOTITE PARALLEL WALLED IMPLANT, 6MM(D) X 13MM(L)	6
FNT513	FULL OSSEOTITE TAPERED IMPLANT, 5MM(D) X 13MM(L)	8	FOS615	FULL OSSEOTITE PARALLEL WALLED IMPLANT, 6MM(D) X 15MM(L)	6
FNT515	FULL OSSEOTITE TAPERED IMPLANT, 5MM(D) X 15MM(L)	8	FOS685	FULL OSSEOTITE PARALLEL WALLED IMPLANT, 6MM(D) X 8.5MM(L)	6
FNT585	FULL OSSEOTITE TAPERED IMPLANT, 5MM(D) X 8.5MM(L)	8	FOSM307	FULL OSSEOTITE PARALLEL WALLED IMPLANT, 3.25MM(D) X 7MM(L)	6
FNT610	FULL OSSEOTITE TAPERED IMPLANT, 6MM(D) X 10MM(L)	8	FOSM310	FULL OSSEOTITE PARALLEL WALLED IMPLANT, 3.25MM(D) X 10MM(L)	6
FNT611	FULL OSSEOTITE TAPERED IMPLANT, 6MM(D) X 11.5MM(L)	8	FOSM311	FULL OSSEOTITE PARALLEL WALLED IMPLANT, 3.25MM(D) X 11.5MM(L)	6
FNT613	FULL OSSEOTITE TAPERED IMPLANT, 6MM(D) X 13MM(L)	8	FOSM313	FULL OSSEOTITE PARALLEL WALLED IMPLANT, 3.25MM(D) X 13MM(L)	6
FNT615	FULL OSSEOTITE TAPERED IMPLANT, 6MM(D) X 15MM(L)	8	FOSM315	FULL OSSEOTITE PARALLEL WALLED IMPLANT, 3.25MM(D) X 15MM(L)	6
FNT685	FULL OSSEOTITE TAPERED IMPLANT, 6MM(D) X 8.5MM(L)	8	FOSM385	FULL OSSEOTITE PARALLEL WALLED IMPLANT, 3.25MM(D) X 8.5MM(L)	6
FOS307	FULL OSSEOTITE PARALLEL WALLED IMPLANT, 3.75MM(D) X 7MM(L)	6	IBPGP	CERTAIN® GUIDE FOR BONE PROFILER (3PK), 4.1, 5, 6MM(D)	37
FOS310	FULL OSSEOTITE PARALLEL WALLED IMPLANT, 3.75MM(D) X 10MM(L)	6	IBPMGP	CERTAIN 3.4MM(D) BONE PROFILING GUIDE PIN (3PK)	37
FOS311	FULL OSSEOTITE PARALLEL WALLED IMPLANT, 3.75MM(D) X 11.5MM(L)	6	IC015	IMPLANT CARRIER, 15MM	40
FOS313	FULL OSSEOTITE PARALLEL WALLED IMPLANT, 3.75MM(D) X 13MM(L)	6	IC100	SURGICAL INDEX COPING	43
FOS315	FULL OSSEOTITE PARALLEL WALLED IMPLANT, 3.75MM(D) X 15MM(L)	6	ICD100	CERTAIN COUNTERSINK REUSABLE DRILL, PREVAIL® 3/4/3MM(P)	29,32,34,36
FOS3207	FULL OSSEOTITE XP® MINIPLANT®, 3.25MM(D) X 4.1MM(P) X 7MM(L)	6	ICS275	CERTAIN IMPLANT HEADLESS COVER SCREW, 4.1, 5, 6MM(D)	1,2,3,4
FOS3210	FULL OSSEOTITE XP MINIPLANT, 3.25MM(D) X 4.1MM(P) X 10MM(L)	6	ICS375	CERTAIN IMPLANT COVER SCREW, 4.1MM(D) X 1MM(H)	1,2,3,4
FOS3211	FULL OSSEOTITE XP MINIPLANT, 3.25MM(D) X 4.1MM(P) X 11.5MM(L)	6	ICS500	CERTAIN IMPLANT COVER SCREW, 5MM(D) X 1MM(H)	1,2,3,4
FOS3213	FULL OSSEOTITE XP MINIPLANT, 3.25MM(D) X 4.1MM(P) X 13MM(L)	6	ICS600	CERTAIN IMPLANT COVER SCREW, 6MM(D) X 1MM(H)	2,3,4
FOS3215	FULL OSSEOTITE XP MINIPLANT, 3.25MM(D) X 4.1MM(P) X 15MM(L)	6	ICSF41	CERTAIN FLAT IMPLANT COVER SCREW, 4.1MM(D)	1,2,3,4
FOS3285	FULL OSSEOTITE XP MINIPLANT, 3.25MM(D) X 4.1MM(P) X 8.5MM(L)	6	ICSF50	CERTAIN FLAT IMPLANT COVER SCREW, 5MM(D)	1,2,3,4
FOS385	FULL OSSEOTITE PARALLEL WALLED IMPLANT, 3.75MM(D) X 8.5MM(L)	6	ICSF60	CERTAIN FLAT IMPLANT COVER SCREW, 6MM(D)	2,3,4
FOS407	FULL OSSEOTITE PARALLEL WALLED IMPLANT, 4MM(D) X 7MM(L)	6	IDI001	CERTAIN DIRECTION INDICATOR, 10MM(L)	40
FOS410	FULL OSSEOTITE PARALLEL WALLED IMPLANT, 4MM(D) X 10MM(L)	6	IDIKT	CERTAIN DIRECTION INDICATOR KIT	40
FOS411	FULL OSSEOTITE PARALLEL WALLED IMPLANT, 4MM(D) X 11.5MM(L)	6	IDIM01	CERTAIN DIRECTION INDICATOR, 3.25MM(D) X 10MM(L)	40
FOS413	FULL OSSEOTITE PARALLEL WALLED IMPLANT, 4MM(D) X 13MM(L)	6	IEHA343	CERTAIN ENCODE® 2-PC EP® HEALING ABUTMENT, 3.4MM(D) X 3.8MM(P) X 3MM(H)	9
FOS415	FULL OSSEOTITE PARALLEL WALLED IMPLANT, 4MM(D) X 15MM(L)	6	IEHA344	CERTAIN ENCODE 2-PC EP HEALING ABUTMENT, 3.4MM(D) X 3.8MM(P) X 4MM(H)	9
FOS4507	FULL OSSEOTITE XP IMPLANT, 4MM(D) X 5MM(P) X 7MM(L)	6	IEHA346	CERTAIN ENCODE 2-PC EP HEALING ABUTMENT, 3.4MM(D) X 3.8MM(P) X 6MM(H)	9
FOS4510	FULL OSSEOTITE XP IMPLANT, 4MM(D) X 5MM(P) X 10MM(L)	6	IEHA348	CERTAIN ENCODE 2-PC EP HEALING ABUTMENT, 3.4MM(D) X 3.8MM(P) X 8MM(H)	9
FOS4511	FULL OSSEOTITE XP IMPLANT, 4MM(D) X 5MM(P) X 11.5MM(L)	6	IEHA353	CERTAIN ENCODE 2-PC EP HEALING ABUTMENT, 3.4MM(D) X 5MM(P) X 3MM(H)	9
FOS4513	FULL OSSEOTITE XP IMPLANT, 4MM(D) X 5MM(P) X 13MM(L)	6	IEHA354	CERTAIN ENCODE 2-PC EP HEALING ABUTMENT, 3.4MM(D) X 5MM(P) X 4MM(H)	9
FOS4515	FULL OSSEOTITE XP IMPLANT, 4MM(D) X 5MM(P) X 15MM(L)	6	IEHA356	CERTAIN ENCODE 2-PC EP HEALING ABUTMENT, 3.4MM(D) X 5MM(P) X 6MM(H)	9
FOS4585	FULL OSSEOTITE XP IMPLANT, 4MM(D) X 5MM(P) X 8.5MM(L)	6	IEHA358	CERTAIN ENCODE 2-PC EP HEALING ABUTMENT, 3.4MM(D) X 5MM(P) X 8MM(H)	9
FOS485	FULL OSSEOTITE PARALLEL WALLED IMPLANT, 4MM(D) X 8.5MM(L)	6	IEHA443	CERTAIN ENCODE 2-PC EP HEALING ABUTMENT, 4.1MM(D) X 4.1MM(P) X 3MM(H)	9
FOS507	FULL OSSEOTITE PARALLEL WALLED IMPLANT, 5MM(D) X 7MM(L)	6	IEHA444	CERTAIN ENCODE 2-PC EP HEALING ABUTMENT, 4.1MM(D) X 4.1MM(P) X 4MM(H)	9
FOS510	FULL OSSEOTITE PARALLEL WALLED IMPLANT, 5MM(D) X 10MM(L)	6	IEHA446	CERTAIN ENCODE 2-PC EP HEALING ABUTMENT, 4.1MM(D) X 4.1MM(P) X 6MM(H)	9
FOS511	FULL OSSEOTITE PARALLEL WALLED IMPLANT, 5MM(D) X 11.5MM(L)	6	IEHA448	CERTAIN ENCODE 2-PC EP HEALING ABUTMENT, 4.1MM(D) X 4.1MM(P) X 8MM(H)	9
FOS513	FULL OSSEOTITE PARALLEL WALLED IMPLANT, 5MM(D) X 13MM(L)	6			
FOS515	FULL OSSEOTITE PARALLEL WALLED IMPLANT, 5MM(D) X 15MM(L)	6			
FOS5607	FULL OSSEOTITE XP IMPLANT, 5MM(D) X 6MM(P) X 7MM(L)	6			
FOS5610	FULL OSSEOTITE XP IMPLANT, 5MM(D) X 6MM(P) X 10MM(L)	6			
FOS5611	FULL OSSEOTITE XP IMPLANT, 5MM(D) X 6MM(P) X 11.5MM(L)	6			
FOS5613	FULL OSSEOTITE XP IMPLANT, 5MM(D) X 6MM(P) X 13MM(L)	6			
FOS5615	FULL OSSEOTITE XP IMPLANT, 5MM(D) X 6MM(P) X 15MM(L)	6			
FOS5685	FULL OSSEOTITE XP IMPLANT, 5MM(D) X 6MM(P) X 8.5MM(L)	6			
FOS585	FULL OSSEOTITE PARALLEL WALLED IMPLANT, 5MM(D) X 8.5MM(L)	6			

Index

Cat.#	Description	Page#	Cat.#	Description	Page#
IEHA453	CERTAIN® ENCODE® 2-PC EP HEALING ABUTMENT, 4.1MM(D) X 5MM(P) X 3MM(H)	9	IEHA668	CERTAIN ENCODE 2-PC EP HEALING ABUTMENT, 6MM(D) X 6MM(P) X 8MM(H)	10
IEHA454	CERTAIN ENCODE 2-PC EP® HEALING ABUTMENT, 4.1MM(D) X 5MM(P) X 4MM(H)	9	IEHA673	CERTAIN ENCODE 2-PC EP HEALING ABUTMENT, 6MM(D) X 7.5MM(P) X 3MM(H)	10
IEHA456	CERTAIN ENCODE 2-PC EP HEALING ABUTMENT, 4.1MM(D) X 5MM(P) X 6MM(H)	9	IEHA674	CERTAIN ENCODE 2-PC EP HEALING ABUTMENT, 6MM(D) X 7.5MM(P) X 4MM(H)	10
IEHA458	CERTAIN ENCODE 2-PC EP HEALING ABUTMENT, 4.1MM(D) X 5MM(P) X 8MM(H)	9	IEHA676	CERTAIN ENCODE 2-PC EP HEALING ABUTMENT, 6MM(D) X 7.5MM(P) X 6MM(H)	10
IEHA463	CERTAIN ENCODE 2-PC EP HEALING ABUTMENT, 4.1MM(D) X 6MM(P) X 3MM(H)	9	IEHA678	CERTAIN ENCODE 2-PC EP HEALING ABUTMENT, 6MM(D) X 7.5MM(P) X 8MM(H)	10
IEHA464	CERTAIN ENCODE 2-PC EP HEALING ABUTMENT, 4.1MM(D) X 6MM(P) X 4MM(H)	9	IFNT3210	FULL OSSEOTITE® TAPERED CERTAIN IMPLANT, 3.25MM(D) X 10MM(L)	4
IEHA466	CERTAIN ENCODE 2-PC EP HEALING ABUTMENT, 4.1MM(D) X 6MM(P) X 6MM(H)	9	IFNT3211	FULL OSSEOTITE TAPERED CERTAIN IMPLANT, 3.25MM(D) X 11.5MM(L)	4
IEHA468	CERTAIN ENCODE 2-PC EP HEALING ABUTMENT, 4.1MM(D) X 6MM(P) X 8MM(H)	9	IFNT3213	FULL OSSEOTITE TAPERED CERTAIN IMPLANT, 3.25MM(D) X 13MM(L)	4
IEHA473	CERTAIN ENCODE 2-PC EP HEALING ABUTMENT, 4.1MM(D) X 7.5MM(P) X 3MM(H)	9	IFNT3215	FULL OSSEOTITE TAPERED CERTAIN IMPLANT, 3.25MM(D) X 15MM(L)	4
IEHA474	CERTAIN ENCODE 2-PC EP HEALING ABUTMENT, 4.1MM(D) X 7.5MM(P) X 4MM(H)	9	IFNT3285	FULL OSSEOTITE TAPERED CERTAIN IMPLANT, 3.25MM(D) X 8.5MM(L)	4
IEHA476	CERTAIN ENCODE 2-PC EP HEALING ABUTMENT, 4.1MM(D) X 7.5MM(P) X 6MM(H)	9	IFNT410	FULL OSSEOTITE TAPERED CERTAIN IMPLANT, 4MM(D) X 10MM(L)	4
IEHA478	CERTAIN ENCODE 2-PC EP HEALING ABUTMENT, 4.1MM(D) X 7.5MM(P) X 8MM(H)	9	IFNT411	FULL OSSEOTITE TAPERED CERTAIN IMPLANT, 4MM(D) X 11.5MM(L)	4
IEHA553	CERTAIN ENCODE 2-PC EP HEALING ABUTMENT, 5MM(D) X 5MM(P) X 3MM(H)	10	IFNT413	FULL OSSEOTITE TAPERED CERTAIN IMPLANT, 4MM(D) X 13MM(L)	4
IEHA554	CERTAIN ENCODE 2-PC EP HEALING ABUTMENT, 5MM(D) X 5MM(P) X 4MM(H)	10	IFNT415	FULL OSSEOTITE TAPERED CERTAIN IMPLANT, 4MM(D) X 15MM(L)	4
IEHA556	CERTAIN ENCODE 2-PC EP HEALING ABUTMENT, 5MM(D) X 5MM(P) X 6MM(H)	10	IFNT485	FULL OSSEOTITE TAPERED CERTAIN IMPLANT, 4MM(D) X 8.5MM(L)	4
IEHA558	CERTAIN ENCODE 2-PC EP HEALING ABUTMENT, 5MM(D) X 5MM(P) X 8MM(H)	10	IFNT510	FULL OSSEOTITE TAPERED CERTAIN IMPLANT, 5MM(D) X 10MM(L)	4
IEHA563	CERTAIN ENCODE 2-PC EP HEALING ABUTMENT, 5MM(D) X 6MM(P) X 3MM(H)	10	IFNT511	FULL OSSEOTITE TAPERED CERTAIN IMPLANT, 5MM(D) X 11.5MM(L)	4
IEHA564	CERTAIN ENCODE 2-PC EP HEALING ABUTMENT, 5MM(D) X 6MM(P) X 4MM(H)	10	IFNT513	FULL OSSEOTITE TAPERED CERTAIN IMPLANT, 5MM(D) X 13MM(L)	4
IEHA566	CERTAIN ENCODE 2-PC EP HEALING ABUTMENT, 5MM(D) X 6MM(P) X 6MM(H)	10	IFNT515	FULL OSSEOTITE TAPERED CERTAIN IMPLANT, 5MM(D) X 15MM(L)	4
IEHA568	CERTAIN ENCODE 2-PC EP HEALING ABUTMENT, 5MM(D) X 6MM(P) X 8MM(H)	10	IFNT585	FULL OSSEOTITE TAPERED CERTAIN IMPLANT, 5MM(D) X 8.5MM(L)	4
IEHA573	CERTAIN ENCODE 2-PC EP HEALING ABUTMENT, 5MM(D) X 7.5MM(P) X 3MM(H)	10	IFNT610	FULL OSSEOTITE TAPERED CERTAIN IMPLANT, 6MM(D) X 10MM(L)	4
IEHA574	CERTAIN ENCODE 2-PC EP HEALING ABUTMENT, 5MM(D) X 7.5MM(P) X 4MM(H)	10	IFNT611	FULL OSSEOTITE TAPERED CERTAIN IMPLANT, 6MM(D) X 11.5MM(L)	4
IEHA576	CERTAIN ENCODE 2-PC EP HEALING ABUTMENT, 5MM(D) X 7.5MM(P) X 6MM(H)	10	IFNT613	FULL OSSEOTITE TAPERED CERTAIN IMPLANT, 6MM(D) X 13MM(L)	4
IEHA578	CERTAIN ENCODE 2-PC EP HEALING ABUTMENT, 5MM(D) X 7.5MM(P) X 8MM(H)	10	IFNT615	FULL OSSEOTITE TAPERED CERTAIN IMPLANT, 6MM(D) X 15MM(L)	4
IEHA663	CERTAIN ENCODE 2-PC EP HEALING ABUTMENT, 6MM(D) X 6MM(P) X 3MM(H)	10	IFNT685	FULL OSSEOTITE TAPERED CERTAIN IMPLANT, 6MM(D) X 8.5MM(L)	4
IEHA664	CERTAIN ENCODE 2-PC EP HEALING ABUTMENT, 6MM(D) X 6MM(P) X 4MM(H)	10	IFOS410	FULL OSSEOTITE PARALLEL WALLED CERTAIN IMPLANT, 4MM(D) X 10MM(L)	3
IEHA666	CERTAIN ENCODE 2-PC EP HEALING ABUTMENT, 6MM(D) X 6MM(P) X 6MM(H)	10	IFOS411	FULL OSSEOTITE PARALLEL WALLED CERTAIN IMPLANT, 4MM(D) X 11.5MM(L)	3
			IFOS413	FULL OSSEOTITE PARALLEL WALLED CERTAIN IMPLANT, 4MM(D) X 13MM(L)	3
			IFOS415	FULL OSSEOTITE PARALLEL WALLED CERTAIN IMPLANT, 4MM(D) X 15MM(L)	3
			IFOS4510	FULL OSSEOTITE XP® CERTAIN IMPLANT, 4MM(D) X 5MM(P) X 10MM(L)	3
			IFOS4511	FULL OSSEOTITE XP CERTAIN IMPLANT, 4MM(D) X 5MM(P) X 11.5MM(L)	3
			IFOS4513	FULL OSSEOTITE XP CERTAIN IMPLANT, 4MM(D) X 5MM(P) X 13MM(L)	3
			IFOS4515	FULL OSSEOTITE XP CERTAIN IMPLANT, 4MM(D) X 5MM(P) X 15MM(L)	3
			IFOS4585	FULL OSSEOTITE XP CERTAIN IMPLANT, 4MM(D) X 5MM(P) X 8.5MM(L)	3
			IFOS485	FULL OSSEOTITE PARALLEL WALLED CERTAIN IMPLANT, 4MM(D) X 8.5MM(L)	3
			IFOS510	FULL OSSEOTITE PARALLEL WALLED CERTAIN IMPLANT, 5MM(D) X 10MM(L)	3
			IFOS511	FULL OSSEOTITE PARALLEL WALLED CERTAIN IMPLANT, 5MM(D) X 11.5MM(L)	3

Index

Cat.#	Description	Page#	Cat.#	Description	Page#
IFOS513	FULL OSSEOTITE® PARALLEL WALLED CERTAIN® IMPLANT, 5MM(D) X 13MM(L)	3	IIOS5411	OSSEOTITE CERTAIN PREVAIL IMPLANT, 5MM(D) X 4.1MM(P) X 11.5MM(L)1	
IFOS515	FULL OSSEOTITE PARALLEL WALLED CERTAIN IMPLANT, 5MM(D) X 15MM(L)	3	IIOS5413	OSSEOTITE CERTAIN PREVAIL IMPLANT, 5MM(D) X 4.1MM(P) X 13MM(L) 1	
IFOS5610	FULL OSSEOTITE XP® CERTAIN IMPLANT, 5MM(D) X 6MM(P) X 10MM(L)	3	IIOS5415	OSSEOTITE CERTAIN PREVAIL IMPLANT, 5MM(D) X 4.1MM(P) X 15MM(L) 1	
IFOS5611	FULL OSSEOTITE XP CERTAIN IMPLANT, 5MM(D) X 6MM(P) X 11.5MM(L)	3	IIOS5485	OSSEOTITE CERTAIN PREVAIL IMPLANT, 5MM(D) X 4.1MM(P) X 8.5MM(L) 1	
IFOS5613	FULL OSSEOTITE XP CERTAIN IMPLANT, 5MM(D) X 6MM(P) X 13MM(L)	3	IIOS5610	OSSEOTITE CERTAIN PREVAIL IMPLANT, 5MM(D) X 5.8MM(C) X 5MM(P) X 10MM(L) 1	
IFOS5615	FULL OSSEOTITE XP CERTAIN IMPLANT, 5MM(D) X 6MM(P) X 15MM(L)	3	IIOS5611	OSSEOTITE CERTAIN PREVAIL IMPLANT, 5MM(D) X 5.8MM(C) X 5MM(P) X 11.5MM(L) 1	
IFOS5685	FULL OSSEOTITE XP CERTAIN IMPLANT, 5MM(D) X 6MM(P) X 8.5MM(L)	3	IIOS5613	OSSEOTITE CERTAIN PREVAIL IMPLANT, 5MM(D) X 5.8MM(C) X 5MM(P) X 13MM(L) 1	
IFOS585	FULL OSSEOTITE PARALLEL WALLED CERTAIN IMPLANT, 5MM(D) X 8.5MM(L)	3	IIOS5615	OSSEOTITE CERTAIN PREVAIL IMPLANT, 5MM(D) X 5.8MM(C) X 5MM(P) X 15MM(L) 1	
IFOS610	FULL OSSEOTITE PARALLEL WALLED CERTAIN IMPLANT, 6MM(D) X 10MM(L)	3	IIOS5685	OSSEOTITE CERTAIN PREVAIL IMPLANT, 5MM(D) X 5.8MM(C) X 5MM(P) X 8.5MM(L) 1	
IFOS611	FULL OSSEOTITE PARALLEL WALLED CERTAIN IMPLANT, 6MM(D) X 11.5MM(L)	3	IIPDTL	CERTAIN IMPLANT PLACEMENT DRIVER (LONG)	30,32,34,44
IFOS613	FULL OSSEOTITE PARALLEL WALLED CERTAIN IMPLANT, 6MM(D) X 13MM(L)	3	IIPDTS	CERTAIN IMPLANT PLACEMENT DRIVER (SHORT)	30,32,34,44
IFOS615	FULL OSSEOTITE PARALLEL WALLED CERTAIN IMPLANT, 6MM(D) X 15MM(L)	3	IMBP4	CERTAIN MANUAL BONE PROFILER, 4.1MM(D) X 5MM(P)	26,37
IFOS685	FULL OSSEOTITE PARALLEL WALLED CERTAIN IMPLANT, 6MM(D) X 8.5MM(L)	3	IMBP5	CERTAIN MANUAL BONE PROFILER, 5MM(D) X 6MM(P)	26,37
IFOSM310	FULL OSSEOTITE PARALLEL WALLED CERTAIN IMPLANT, 3.25MM(D) X 10MM(L)	3	IMCSF34	CERTAIN FLAT IMPLANT COVER SCREW, 3.4MM(D)	1,2,3,4
IFOSM311	FULL OSSEOTITE PARALLEL WALLED CERTAIN IMPLANT, 3.25MM(D) X 11.5MM(L)	3	IMHA32	CERTAIN EP® HEALING ABUTMENT, 3.4MM(D) X 3.8MM(P) X 2MM(H)	11
IFOSM313	FULL OSSEOTITE PARALLEL WALLED CERTAIN IMPLANT, 3.25MM(D) X 13MM(L)	3	IMHA33	CERTAIN EP HEALING ABUTMENT, 3.4MM(D) X 3.8MM(P) X 3MM(H)	11
IFOSM315	FULL OSSEOTITE PARALLEL WALLED CERTAIN IMPLANT, 3.25MM(D) X 15MM(L)	3	IMHA34	CERTAIN EP HEALING ABUTMENT, 3.4MM(D) X 3.8MM(P) X 4MM(H)	11
IFOSM385	FULL OSSEOTITE PARALLEL WALLED CERTAIN IMPLANT, 3.25MM(D) X 8.5MM(L)	3	IMHA36	CERTAIN EP HEALING ABUTMENT, 3.4MM(D) X 3.8MM(P) X 6MM(H)	11
IIOS3410	OSSEOTITE CERTAIN PREVAIL® IMPLANT, 3.25MM(D) X 4.1MM(C) X 3.4MM(P) X 10MM(L)	1	IMMBP	CERTAIN MANUAL BONE PROFILER, 3.4MM(D) X 4.1MM(P)	26,37
IIOS3411	OSSEOTITE CERTAIN PREVAIL IMPLANT, 3.25MM(D) X 4.1MM(C) X 3.4MM(P) X 11.5MM(L)	1	IMMCS1	CERTAIN COVER SCREW, 3.4MM(D) X 1MM(H)	1,2,3,4
IIOS3413	OSSEOTITE CERTAIN PREVAIL IMPLANT, 3.25MM(D) X 4.1MM(C) X 3.4MM(P) X 13MM(L)	1	IMPDTL	CERTAIN IMPLANT PLACEMENT DRIVER TIP, 3.4MM(D), LONG	30,32,34,44
IIOS3415	OSSEOTITE CERTAIN PREVAIL IMPLANT, 3.25MM(D) X 4.1MM(C) X 3.4MM(P) X 15MM(L)	1	IMPDTS	CERTAIN IMPLANT PLACEMENT DRIVER TIP, 3.4MM(D), SHORT	30,32,34,44
IIOS3485	OSSEOTITE CERTAIN PREVAIL IMPLANT, 3.25MM(D) X 4.1MM(C) X 3.4MM(P) X 8.5MM(L)	1	IMRE100	CERTAIN RATCHET EXTENSION, 3.4MM(D), SHORT	30,32,34,44
IIOS4310	OSSEOTITE CERTAIN PREVAIL IMPLANT, 4MM(D) X 3.4MM(C) X 10MM(L)	1	IMRE200	CERTAIN RATCHET EXTENSION, 3.4MM(D), LONG	30,32,34,44
IIOS4311	OSSEOTITE CERTAIN PREVAIL IMPLANT, 4MM(D) X 3.4MM(C) X 11.5MM(L)	1	INT3210	OSSEOTITE TAPERED CERTAIN IMPLANT, 3.25MM(D) X 10MM(L)	4
IIOS4313	OSSEOTITE CERTAIN PREVAIL IMPLANT, 4MM(D) X 3.4MM(P) X 13MM(L)	1	INT3211	OSSEOTITE TAPERED CERTAIN IMPLANT, 3.25MM(D) X 11.5MM(L)	4
IIOS4315	OSSEOTITE CERTAIN PREVAIL IMPLANT, 4MM(D) X 3.4MM(C) X 15MM(L)	1	INT3213	OSSEOTITE TAPERED CERTAIN IMPLANT, 3.25MM(D) X 13MM(L)	4
IIOS4385	OSSEOTITE CERTAIN PREVAIL IMPLANT, 4MM(D) X 3.4MM(C) X 8.5MM(L)	1	INT3215	OSSEOTITE TAPERED CERTAIN IMPLANT, 3.25MM(D) X 15MM(L)	4
IIOS4510	OSSEOTITE CERTAIN PREVAIL IMPLANT 4MM(D) X 4.8MM(C) X 4.1MM(P) X 10MM(L)	1	INT3285	OSSEOTITE TAPERED CERTAIN IMPLANT, 3.25MM(D) X 8.5MM(L)	4
IIOS4511	OSSEOTITE CERTAIN PREVAIL IMPLANT, 4MM(D) X 4.8MM(C) X 4.1MM(P) X 11.5MM(L)	1	INT410	OSSEOTITE TAPERED CERTAIN IMPLANT, 4MM(D) X 10MM(L)	4
IIOS4513	OSSEOTITE CERTAIN PREVAIL IMPLANT, 4MM(D) X 4.8MM(C) X 4.1MM(P) X 13MM(L)	1	INT411	OSSEOTITE TAPERED CERTAIN IMPLANT, 4MM(D) X 11.5MM(L)	4
IIOS4515	OSSEOTITE CERTAIN PREVAIL IMPLANT, 4MM(D) X 4.8MM(C) X 4.1MM(P) X 15MM(L)	1	INT413	OSSEOTITE TAPERED CERTAIN IMPLANT, 4MM(D) X 13MM(L)	4
IIOS4585	OSSEOTITE CERTAIN PREVAIL IMPLANT, 4MM(D) X 4.8MM(C) X 4.1MM(P) X 8.5MM(L)	1	INT415	OSSEOTITE TAPERED CERTAIN IMPLANT, 4MM(D) X 15MM(L)	4
IIOS5410	OSSEOTITE CERTAIN PREVAIL IMPLANT, 5MM(D) X 4.1MM(P) X 10MM(L)	1	INT485	OSSEOTITE TAPERED CERTAIN IMPLANT, 4MM(D) X 8.5MM(L)	4
			INT510	OSSEOTITE TAPERED CERTAIN IMPLANT, 5MM(D) X 10MM(L)	4
			INT511	OSSEOTITE TAPERED CERTAIN IMPLANT, 5MM(D) X 11.5MM(L)	4
			INT513	OSSEOTITE TAPERED CERTAIN IMPLANT, 5MM(D) X 13MM(L)	4
			INT515	OSSEOTITE TAPERED CERTAIN IMPLANT, 5MM(D) X 15MM(L)	4
			INT585	OSSEOTITE TAPERED CERTAIN IMPLANT, 5MM(D) X 8.5MM(L)	4
			INT610	OSSEOTITE TAPERED CERTAIN IMPLANT, 6MM(D) X 10MM(L)	4
			INT611	OSSEOTITE TAPERED CERTAIN IMPLANT, 6MM(D) X 11.5MM(L)	4
			INT613	OSSEOTITE TAPERED CERTAIN IMPLANT, 6MM(D) X 13MM(L)	4
			INT615	OSSEOTITE TAPERED CERTAIN IMPLANT, 6MM(D) X 15MM(L)	4
			INT685	OSSEOTITE TAPERED CERTAIN IMPLANT, 6MM(D) X 8.5MM(L)	4
			INTMODSET 3X MODEL SET WITH OSSEOTITE TAPERED CERTAIN IMPLANT AND GINGIHUE® POST	51	
			IOS4510	OSSEOTITE XP CERTAIN IMPLANT, 4MM(D) X 5MM(P) X 10MM(L)	3
			IOS4511	OSSEOTITE XP CERTAIN IMPLANT, 4MM(D) X 5MM(P) X 11.5MM(L)	3

Index

Cat.#	Description	Page#	Cat.#	Description	Page#
IOS4513	OSSEOTITE XP® CERTAIN® IMPLANT, 4MM(D) X 5MM(P) X 13MM(L)	3	ISWHA62	CERTAIN EP HEALING ABUTMENT, 6MM(D) X 0MM(P) X 2MM(H)	12
IOS4515	OSSEOTITE XP CERTAIN IMPLANT, 4MM(D) X 5MM(P) X 15MM(L)	3	ISWHA63	CERTAIN EP HEALING ABUTMENT, 6MM(D) X 0MM(P) X 3MM(H)	12
IOS4585	OSSEOTITE XP CERTAIN IMPLANT, 4MM(D) X 5MM(P) X 8.5MM(L)	3	ISWHA64	CERTAIN EP HEALING ABUTMENT, 6MM(D) X 0MM(P) X 4MM(H)	12
IOS5610	OSSEOTITE XP CERTAIN IMPLANT, 5MM(D) X 6MM(P) X 10MM(L)	3	ISWHA66	CERTAIN EP HEALING ABUTMENT, 6MM(D) X 0MM(P) X 6MM(H)	12
IOS5611	OSSEOTITE XP CERTAIN IMPLANT, 5MM(D) X 6MM(P) X 11.5MM(L)	3	ISWHA68	CERTAIN EP HEALING ABUTMENT, 6MM(D) X 0MM(P) X 8MM(H)	12
IOS5613	OSSEOTITE XP CERTAIN IMPLANT, 5MM(D) X 6MM(P) X 13MM(L)	3	ITD210	IRRIGATED TWIST DRILL, 2.3MM X 10MM	35
IOS5615	OSSEOTITE XP CERTAIN IMPLANT, 5MM(D) X 6MM(P) X 15MM(L)	3	ITD215	IRRIGATED TWIST DRILL, 2.3MM X 15MM	35
IOS5685	OSSEOTITE XP CERTAIN IMPLANT, 5MM(D) X 6MM(P) X 8.5MM(L)	3	ITD220	IRRIGATED TWIST DRILL, 2.3MM X 20MM	35
IOSM310	OSSEOTITE PARALLEL WALLED CERTAIN IMPLANT, 3.25MM(D) X 10MM(L)	3	ITD2710	IRRIGATED TWIST DRILL, 2.75MM X 10MM	35
IOSM311	OSSEOTITE PARALLEL WALLED CERTAIN IMPLANT, 3.25MM(D) X 11.5MM(L)	3	ITD2715	IRRIGATED TWIST DRILL, 2.75MM X 15MM	35
IOSM313	OSSEOTITE PARALLEL WALLED CERTAIN IMPLANT, 3.25MM(D) X 13MM(L)	3	ITD2720	IRRIGATED TWIST DRILL, 2.75MM X 20MM	35
IOSM315	OSSEOTITE PARALLEL WALLED CERTAIN IMPLANT, 3.25MM(D) X 15MM(L)	3	ITD310	IRRIGATED TWIST DRILL, 3MM X 10MM	35
IOSM318	OSSEOTITE PARALLEL WALLED CERTAIN IMPLANT, 3.25MM(D) X 18MM(L)	3	ITD3110	IRRIGATED TWIST DRILL, 3.15MM X 10MM	35
3IOSM385	OSSEOTITE PARALLEL WALLED CERTAIN IMPLANT, 3.25MM(D) X 8.5MM(L)	3	ITD3115	IRRIGATED TWIST DRILL, 3.15MM X 15MM	35
IOSS410	OSSEOTITE PARALLEL WALLED CERTAIN IMPLANT, 4MM(D) X 10MM(L)	3	ITD3120	IRRIGATED TWIST DRILL, 3.15MM X 20MM	35
IOSS411	OSSEOTITE PARALLEL WALLED CERTAIN IMPLANT, 4MM(D) X 11.5MM(L)	3	ITD315	IRRIGATED TWIST DRILL 3MM X 15MM	35
IOSS413	OSSEOTITE PARALLEL WALLED CERTAIN IMPLANT, 4MM(D) X 13MM(L)	3	ITD320	IRRIGATED TWIST DRILL, 3MM X 20MM	35
IOSS415	OSSEOTITE PARALLEL WALLED CERTAIN IMPLANT, 4MM(D) X 15MM(L)	3	ITD3210	IRRIGATED TWIST DRILL, 3.25MM X 10MM	35
IOSS418	OSSEOTITE PARALLEL WALLED CERTAIN IMPLANT, 4MM(D) X 18MM(L)	3	ITD3215	IRRIGATED TWIST DRILL, 3.25MM X 15MM	35
IOSS420	OSSEOTITE PARALLEL WALLED CERTAIN IMPLANT, 4MM(D) X 20MM(L)	3	ITD3220	IRRIGATED TWIST DRILL, 3.25MM X 20MM	35
IOSS485	OSSEOTITE PARALLEL WALLED CERTAIN IMPLANT, 4MM(D) X 8.5MM(L)	3	ITD4218	IRRIGATED TWIST DRILL, 4.25MM X 18MM	35
IOSS510	OSSEOTITE PARALLEL WALLED CERTAIN IMPLANT, 5MM(D) X 10MM(L)	3	ITD423	IRRIGATED TWIST DRILL, 4.25MM X 13MM	35
IOSS511	OSSEOTITE PARALLEL WALLED CERTAIN IMPLANT, 5MM(D) X 11.5MM(L)	3	ITD428	IRRIGATED TWIST DRILL, 4.25MM X 8.5MM	35
IOSS513	OSSEOTITE PARALLEL WALLED CERTAIN IMPLANT, 5MM(D) X 13MM(L)	3	ITD5218	IRRIGATED TWIST DRILL, 5.25MM X 18MM	35
IOSS515	OSSEOTITE PARALLEL WALLED CERTAIN IMPLANT, 5MM(D) X 15MM(L)	3	ITD523	IRRIGATED TWIST DRILL, 5.25MM X 13MM	35
IOSS585	OSSEOTITE PARALLEL WALLED CERTAIN IMPLANT, 5MM(D) X 8.5MM(L)	3	ITD528	IRRIGATED TWIST DRILL, 5.25MM X 8.5MM	35
IOSS610	OSSEOTITE PARALLEL WALLED CERTAIN IMPLANT, 6MM(D) X 10MM(L)	3	ITHA52	CERTAIN EP HEALING ABUTMENT, 4.1MM(D) X 5MM(P) X 2MM(H)	11
IOSS611	OSSEOTITE PARALLEL WALLED CERTAIN IMPLANT, 6MM(D) X 11.5MM(L)	3	ITHA53	CERTAIN EP HEALING ABUTMENT, 4.1MM(D) X 5MM(P) X 3MM(H)	11
IOSS613	OSSEOTITE PARALLEL WALLED CERTAIN IMPLANT, 6MM(D) X 13MM(L)	3	ITHA54	CERTAIN EP HEALING ABUTMENT, 4.1MM(D) X 5MM(P) X 4MM(H)	11
IOSS615	OSSEOTITE PARALLEL WALLED CERTAIN IMPLANT, 6MM(D) X 15MM(L)	3	ITHA56	CERTAIN EP HEALING ABUTMENT, 4.1MM(D) X 5MM(P) X 6MM(H)	11
IOSS685	OSSEOTITE PARALLEL WALLED CERTAIN IMPLANT, 6MM(D) X 8.5MM(L)	3	ITHA58	CERTAIN EP HEALING ABUTMENT, 4.1MM(D) X 5MM(P) X 8MM(H)	11
IRE100	CERTAIN RATCHET EXTENSION (SHORT) 6MM(L)	30,32,34,44	ITHA63	CERTAIN EP HEALING ABUTMENT, 4.1MM(D) X 6MM(P) X 3MM(H)	11
IRE200	CERTAIN RATCHET EXTENSION (LONG) 15MM(L)	30,32,34,44	ITHA64	CERTAIN EP HEALING ABUTMENT, 4.1MM(D) X 6MM(P) X 4MM(H)	11
IRORDR	CERTAIN DRIVER REPLACEMENT O-RINGS, QTY:10	30,32,34,44	ITHA66	CERTAIN EP HEALING ABUTMENT, 4.1MM(D) X 6MM(P) X 6MM(H)	11
ISHA42	CERTAIN EP® HEALING ABUTMENT, 4.1MM(D) X 0MM(P) X 2MM(H)	11	ITHA68	CERTAIN EP HEALING ABUTMENT, 4.1MM(D) X 6MM(P) X 8MM(H)	11
ISHA43	CERTAIN EP HEALING ABUTMENT, 4.1MM(D) X 0MM(P) X 3MM(H)	11	ITHA73	CERTAIN EP HEALING ABUTMENT, 4.1MM(D) X 7.5MM(P) X 3MM(H)	11
ISHA44	CERTAIN EP HEALING ABUTMENT, 4.1MM(D) X 0MM(P) X 4MM(H)	11	ITHA74	CERTAIN EP HEALING ABUTMENT, 4.1MM(D) X 7.5MM(P) X 4MM(H)	11
ISHA46	CERTAIN EP HEALING ABUTMENT, 4.1MM(D) X 0MM(P) X 6MM(H)	11	ITHA76	CERTAIN EP HEALING ABUTMENT, 4.1MM(D) X 7.5MM(P) X 6MM(H)	11
ISHA48	CERTAIN EP HEALING ABUTMENT, 4.1MM(D) X 0MM(P) X 8MM(H)	11	ITHA78	CERTAIN EP HEALING ABUTMENT, 4.1MM(D) X 7.5MM(P) X 8MM(H)	11
ISMHA32	CERTAIN EP HEALING ABUTMENT, 3.4MM(D) X 0MM(P) X 2MM(H)	11	IWTH52	CERTAIN EP HEALING ABUTMENT, 5MM(D) X 5MM(P) X 2MM(H)	12
ISMHA33	CERTAIN EP HEALING ABUTMENT, 3.4MM(D) X 0MM(P) X 3MM(H)	11	IWTH53	CERTAIN EP HEALING ABUTMENT, 5MM(D) X 5MM(P) X 3MM(H)	12
ISMHA34	CERTAIN EP HEALING ABUTMENT, 3.4MM(D) X 0MM(P) X 4MM(H)	11	IWTH54	CERTAIN EP HEALING ABUTMENT, 5MM(D) X 5MM(P) X 4MM(H)	12
ISMHA36	CERTAIN EP HEALING ABUTMENT, 3.4MM(D) X 0MM(P) X 6MM(H)	11	IWTH56	CERTAIN EP HEALING ABUTMENT, 5MM(D) X 5MM(P) X 6MM(H)	12
ISWHA52	CERTAIN EP HEALING ABUTMENT, 5MM(D) X 0MM(P) X 2MM(H)	12	IWTH562	CERTAIN EP HEALING ABUTMENT, 5MM(D) X 6MM(P) X 2MM(H)	12
ISWHA53	CERTAIN EP HEALING ABUTMENT, 5MM(D) X 0MM(P) X 3MM(H)	12	IWTH563	CERTAIN EP HEALING ABUTMENT, 5MM(D) X 6MM(P) X 3MM(H)	12
ISWHA54	CERTAIN EP HEALING ABUTMENT, 5MM(D) X 0MM(P) X 4MM(H)	12	IWTH564	CERTAIN EP HEALING ABUTMENT, 5MM(D) X 6MM(P) X 4MM(H)	12
ISWHA56	CERTAIN EP HEALING ABUTMENT, 5MM(D) X 0MM(P) X 6MM(H)	12	IWTH566	CERTAIN EP HEALING ABUTMENT, 5MM(D) X 6MM(P) X 6MM(H)	12
ISWHA58	CERTAIN EP HEALING ABUTMENT, 5MM(D) X 0MM(P) X 8MM(H)	12	IWTH568	CERTAIN EP HEALING ABUTMENT, 5MM(D) X 6MM(P) X 8MM(H)	12

Index

Cat.#	Description	Page#	Cat.#	Description	Page#
IWTH572	CERTAIN® EP® HEALING ABUTMENT, 5MM(D) X 7.5MM(P) X 2MM(H)	12	MTAP2	IMPLANT TAP, 3.25MM X 27MM(L)	31,33,38
IWTH573	CERTAIN EP HEALING ABUTMENT, 5MM(D) X 7.5MM(P) X 3MM(H)	12	NIIOS3410	NANOTITE™ CERTAIN PREVAIL® IMPLANT, 3.25MM(D) X 4.1MM(C) X 3.4MM(P) X 10MM(L)	1
IWTH574	CERTAIN EP HEALING ABUTMENT, 5MM(D) X 7.5MM(P) X 4MM(H)	12	NIIOS3411	NANOTITE CERTAIN PREVAIL IMPLANT, 3.25MM(D) X 4.1MM(C) X 3.4MM(P) X 11.5MM(L)	1
IWTH576	CERTAIN EP HEALING ABUTMENT, 5MM(D) X 7.5MM(P) X 6MM(H)	12	NIIOS3413	NANOTITE CERTAIN PREVAIL IMPLANT, 3.25MM(D) X 4.1MM(C) X 3.4MM(P) X 13MM(L)	1
IWTH578	CERTAIN EP HEALING ABUTMENT, 5MM(D) X 7.5MM(P) X 8MM(H)	12	NIIOS3415	NANOTITE CERTAIN PREVAIL IMPLANT, 3.25MM(D) X 4.1MM(C) X 3.4MM(P) X 15MM(L)	1
IWTH58	CERTAIN EP HEALING ABUTMENT, 5MM(D) X 5MM(P) X 8MM(H)	12	NIIOS3485	NANOTITE CERTAIN PREVAIL IMPLANT, 3.25MM(D) X 4.1MM(C) X 3.4MM(P) X 8.5MM(L)	1
IWTH62	CERTAIN EP HEALING ABUTMENT, 6MM(D) X 6MM(P) X 2MM(H)	12	NIIOS4310	NANOTITE CERTAIN PREVAIL IMPLANT, 4MM(D) X 3.4MM(C) X 10MM(L)	1
IWTH63	CERTAIN EP HEALING ABUTMENT, 6MM(D) X 6MM(P) X 3MM(H)	12	NIIOS4311	NANOTITE CERTAIN PREVAIL IMPLANT, 4MM(D) X 3.4MM(C) X 11.5MM(L)	1
IWTH64	CERTAIN EP HEALING ABUTMENT, 6MM(D) X 6MM(P) X 4MM(H)	12	NIIOS4313	NANOTITE CERTAIN PREVAIL IMPLANT, 4MM(D) X 3.4MM(C) X 13MM(L)	1
IWTH66	CERTAIN EP HEALING ABUTMENT, 6MM(D) X 6MM(P) X 6MM(H)	12	NIIOS4315	NANOTITE CERTAIN PREVAIL IMPLANT, 4MM(D) X 3.4MM(C) X 15MM(L)	1
IWTH672	CERTAIN EP HEALING ABUTMENT, 6MM(D) X 7.5MM(P) X 2MM(H)	12	NIIOS4385	NANOTITE CERTAIN PREVAIL IMPLANT, 4MM(D) X 3.4MM(C) X 8.5MM(L)	1
IWTH673	CERTAIN EP HEALING ABUTMENT, 6MM(D) X 7.5MM(P) X 3MM(H)	12	NIIOS4510	NANOTITE CERTAIN PREVAIL IMPLANT, 4MM(D) X 4.8MM(C) X 4.1MM(P) X 10MM(L)	1
IWTH674	CERTAIN EP HEALING ABUTMENT, 6MM(D) X 7.5MM(P) X 4MM(H)	12	NIIOS4511	NANOTITE CERTAIN PREVAIL IMPLANT, 4MM(D) X 4.8MM(C) X 4.1MM(P) X 11.5MM(L)	1
IWTH676	CERTAIN EP HEALING ABUTMENT, 6MM(D) X 7.5MM(P) X 6MM(H)	12	NIIOS4513	NANOTITE CERTAIN PREVAIL IMPLANT, 4MM(D) X 4.8MM(C) X 4.1MM(P) X 13MM(L)	1
IWTH678	CERTAIN EP HEALING ABUTMENT, 6MM(D) X 7.5MM(P) X 8MM(H)	12	NIIOS4515	NANOTITE CERTAIN PREVAIL IMPLANT, 4MM(D) X 4.8MM(C) X 4.1MM(P) X 15MM(L)	1
IWTH68	CERTAIN EP HEALING ABUTMENT, 6MM(D) X 6MM(P) X 8MM(H)	12	NIIOS4585	NANOTITE CERTAIN PREVAIL IMPLANT, 4MM(D) X 4.8MM(C) X 4.1MM(P) X 8.5MM(L)	1
MALL1	MALLET, STAINLESS STEEL	42	NIIOS5485	NANOTITE CERTAIN PREVAIL IMPLANT, 5MM(D) X 4.1MM(P) X 8.5MM(L)	1
MDR10	HANDPIECE CONNECTOR	26,30,31,33,43	NIIOS5410	NANOTITE CERTAIN PREVAIL IMPLANT, 5MM(D) X 4.1MM(P) X 10MM(L)	1
ME100	SMALL MEMBRANE ELEVATOR	46	NIIOS5411	NANOTITE CERTAIN PREVAIL IMPLANT, 5MM(D) X 4.1MM(P) X 11MM(L)	1
ME200	MEDIUM MEMBRANE ELEVATOR	46	NIIOS5413	NANOTITE CERTAIN PREVAIL IMPLANT, 5MM(D) X 4.1MM(P) X 13MM(L)	1
ME300	LARGE MEMBRANE ELEVATOR	46	NIIOS5415	NANOTITE CERTAIN PREVAIL IMPLANT, 5MM(D) X 4.1MM(P) X 15MM(L)	1
MHA32	EP HEALING ABUTMENT, 3.4MM(D) X 3.8MM(P) X 2MM(H)	15	NIIOS5610	NANOTITE CERTAIN PREVAIL IMPLANT, 5MM(D) X 5.8MM(C) X 5MM(P) X 10MM(L)	1
MHA33	EP HEALING ABUTMENT, 3.4MM(D) X 3.8MM(P) X 3MM(H)	15	NIIOS5611	NANOTITE CERTAIN PREVAIL IMPLANT, 5MM(D) X 5.8MM(C) X 5MM(P) X 11.5MM(L)	1
MHA34	EP HEALING ABUTMENT, 3.4MM(D) X 3.8MM(P) X 4MM(H)	15	NIIOS5613	NANOTITE CERTAIN PREVAIL IMPLANT, 5MM(D) X 5.8MM(C) X 5MM(P) X 13MM(L)	1
MHA36	EP HEALING ABUTMENT, 3.4MM(D) X 3.8MM(P) X 6MM(H)	15	NIIOS5615	NANOTITE CERTAIN PREVAIL IMPLANT, 5MM(D) X 5.8MM(C) X 5MM(P) X 15MM(L)	1
MIDTH	MANUAL INTERCHANGEABLE DRIVER TIP HANDLE	43	NIIOS5685	NANOTITE CERTAIN PREVAIL IMPLANT, 5MM(D) X 5.8MM(C) X 5MM(P) X 8.5MM(L)	1
MMC03	IMPLANT MOUNT, 3.4MM(D) X 3MM(L)	40	NIITP4310	NANOTITE TAPERED CERTAIN PREVAIL IMPLANT, 4MM(D) X 3MM(P) X 10MM(L)	2
MMC15	IMPLANT MOUNT, 3.4MM(D) X 15MM(L)	30,31,33,40	NIITP4311	NANOTITE TAPERED CERTAIN PREVAIL IMPLANT, 4MM(D) X 3MM(P) X 11.5MM(L)	2
MMCS1	IMPLANT COVER SCREW, 3.4MM(D) X 1MM(H)	5,6,7,8	NIITP4313	NANOTITE TAPERED CERTAIN PREVAIL IMPLANT, 4MM(D) X 3MM(P) X 13MM(L)	2
MMKIT	IMPLANT MOUNT KIT, 3.4MM(D)	40	NIITP4315	NANOTITE TAPERED CERTAIN PREVAIL IMPLANT, 4MM(D) X 3MM(P) X 15MM(L)	2
MODWRENCH	WRENCH FOR TIGHTENING MODEL SCREWS	51	NIIIT4385	NANOTITE TAPERED CERTAIN PREVAIL IMPLANT, 4MM(D) X 3MM(P) X 8.5MM(L)	2
MSGIAM1	NAVIGATOR® CERTAIN ANALOG MOUNT, 3.4MM(D) X 1(L)	27			
MSGIAM2	NAVIGATOR CERTAIN ANALOG MOUNT, 3.4MM(D) X 2(L)	27			
MSGIAM3	NAVIGATOR CERTAIN ANALOG MOUNT, 3.4MM(D) X 3(L)	27			
MSGIAM4	NAVIGATOR CERTAIN ANALOG MOUNT, 3.4MM(D) X 4(L)	27			
MSGIIM1	NAVIGATOR CERTAIN IMPLANT MOUNT, 3.4MM(D) X 1(L)	26			
MSGIIM2	NAVIGATOR CERTAIN IMPLANT MOUNT, 3.4MM(D) X 2(L)	26			
MSGIIM3	NAVIGATOR CERTAIN IMPLANT MOUNT, 3.4MM(D) X 3(L)	26			
MSGIIM4	NAVIGATOR CERTAIN IMPLANT MOUNT, 3.4MM(D) X 4(L)	26			
MSGSD	NAVIGATOR STARTER DRILL, 3.4MM(D)	25			
MSGTAP	NAVIGATOR BONE TAP, 3.25MM(D)	26			
MT233	2-PC EP HEALING ABUTMENT, 3.4MM(D) X 3.8MM(P) X 3MM(H)	17			
MT234	2-PC EP HEALING ABUTMENT, 3.4MM(D) X 3.8MM(P) X 4MM(H)	17			
MT236	2-PC EP HEALING ABUTMENT, 3.4MM(D) X 3.8MM(P) X 6MM(H)	17			
MT253	2-PC EP HEALING ABUTMENT, 3.4MM(D) X 5MM(P) X 3MM(H)	17			
MT254	2-PC EP HEALING ABUTMENT, 3.4MM(D) X 5MM(P) X 4MM(H)	17			
MT256	2-PC EP HEALING ABUTMENT, 3.4MM(D) X 5MM(P) X 6MM(H)	17			
MTAP1	IMPLANT TAP, 3.25MM X 18MM(L)	38			

Index

Cat.#	Description	Page#	Cat.#	Description	Page#
NIITP5410	NANOTITE™ TAPERED CERTAIN® PREVAIL® IMPLANT, 5MM(D) X 4MM(P) X 10MM(L)	2	NIOSS418	NANOTITE PARALLEL WALLED CERTAIN IMPLANT, 4MM(D) X 18MM(L)	2
NIITP5411	NANOTITE TAPERED CERTAIN PREVAIL IMPLANT, 5MM(D) X 4MM(P) X 11.5MM(L)	2	NIOSS485	NANOTITE PARALLEL WALLED CERTAIN IMPLANT, 4MM(D) X 8.5MM(L)	2
NIITP5413	NANOTITE TAPERED CERTAIN PREVAIL IMPLANT, 5MM(D) X 4MM(P) X 13MM(L)	2	NIOSS510	NANOTITE PARALLEL WALLED CERTAIN IMPLANT, 5MM(D) X 10MM(L)	2
NIITP5415	NANOTITE TAPERED CERTAIN PREVAIL IMPLANT, 5MM(D) X 4MM(P) X 15MM(L)	2	NIOSS511	NANOTITE PARALLEL WALLED CERTAIN IMPLANT, 5MM(D) X 11.5MM(L)	2
NIITP5485	NANOTITE TAPERED CERTAIN PREVAIL IMPLANT, 5MM(D) X 4MM(P) X 8.5MM(L)	2	NIOSS513	NANOTITE PARALLEL WALLED CERTAIN IMPLANT, 5MM(D) X 13MM(L)	2
NIITP6510	NANOTITE TAPERED CERTAIN PREVAIL IMPLANT, 6MM(D) X 5MM(P) X 10MM(L)	2	NIOSS515	NANOTITE PARALLEL WALLED CERTAIN IMPLANT, 5MM(D) X 15MM(L)	2
NIITP6511	NANOTITE TAPERED CERTAIN PREVAIL IMPLANT, 6MM(D) X 5MM(P) X 11.5MM(L)	2	NIOSS585	NANOTITE PARALLEL WALLED CERTAIN IMPLANT, 5MM(D) X 8.5MM(L)	2
NIITP6513	NANOTITE TAPERED CERTAIN PREVAIL IMPLANT, 6MM(D) X 5MM(P) X 13MM(L)	2	NIOSS610	NANOTITE PARALLEL WALLED CERTAIN IMPLANT, 6MM(D) X 10MM(L)	2
NIITP6515	NANOTITE TAPERED CERTAIN PREVAIL IMPLANT, 6MM(D) X 5MM(P) X 15MM(L)	2	NIOSS611	NANOTITE PARALLEL WALLED CERTAIN IMPLANT, 6MM(D) X 11.5MM(L)	2
NIITP6585	NANOTITE TAPERED CERTAIN PREVAIL IMPLANT, 6MM(D) X 5MM(P) X 8.5MM(L)	2	NIOSS613	NANOTITE PARALLEL WALLED CERTAIN IMPLANT, 6MM(D) X 13MM(L)	2
NINT3210	NANOTITE TAPERED CERTAIN IMPLANT, 3.25MM(D) X 10MM(L)	4	NIOSS615	NANOTITE PARALLEL WALLED CERTAIN IMPLANT, 6MM(D) X 15MM(L)	2
NINT3211	NANOTITE TAPERED CERTAIN IMPLANT, 3.25MM(D) X 11.5MM(L)	4	NNT3210	NANOTITE TAPERED IMPLANT, 3.25MM(D) X 10MM(L)	7
NINT3213	NANOTITE TAPERED CERTAIN IMPLANT, 3.25MM(D) X 13MM(L)	4	NNT3211	NANOTITE TAPERED IMPLANT, 3.25MM(D) X 11.5MM(L)	7
NINT3215	NANOTITE TAPERED CERTAIN IMPLANT, 3.25MM(D) X 15MM(L)	4	NNT3213	NANOTITE TAPERED IMPLANT, 3.25MM(D) X 13MM(L)	7
NINT3285	NANOTITE TAPERED CERTAIN IMPLANT, 3.25MM(D) X 8.5MM(L)	4	NNT3215	NANOTITE TAPERED IMPLANT, 3.25MM(D) X 15MM(L)	7
NINT410	NANOTITE TAPERED CERTAIN IMPLANT, 4MM(D) X 10MM(L)	4	NNT3285	NANOTITE TAPERED IMPLANT, 3.25MM(D) X 8.5MM(L)	7
NINT411	NANOTITE TAPERED CERTAIN IMPLANT, 4MM(D) X 11.5MM(L)	4	NNT410	NANOTITE TAPERED IMPLANT, 4MM(D) X 10MM(L)	7
NINT413	NANOTITE TAPERED CERTAIN IMPLANT, 4MM(D) X 13MM(L)	4	NNT411	NANOTITE TAPERED IMPLANT, 4MM(D) X 11.5MM(L)	7
NINT415	NANOTITE TAPERED CERTAIN IMPLANT, 4MM(D) X 15MM(L)	4	NNT413	NANOTITE TAPERED IMPLANT, 4MM(D) X 13MM(L)	7
NINT485	NANOTITE TAPERED CERTAIN IMPLANT, 4MM(D) X 8.5MM(L)	4	NNT415	NANOTITE TAPERED IMPLANT, 4MM(D) X 15MM(L)	7
NINT510	NANOTITE TAPERED CERTAIN IMPLANT, 5MM(D) X 10MM(L)	4	NNT485	NANOTITE TAPERED IMPLANT, 4MM(D) X 8.5MM(L)	7
NINT511	NANOTITE TAPERED CERTAIN IMPLANT, 5MM(D) X 11.5MM(L)	4	NNT510	NANOTITE TAPERED IMPLANT, 5MM(D) X 10MM(L)	7
NINT513	NANOTITE TAPERED CERTAIN IMPLANT, 5MM(D) X 13MM(L)	4	NNT511	NANOTITE TAPERED IMPLANT, 5MM(D) X 11.5MM(L)	7
NINT515	NANOTITE TAPERED CERTAIN IMPLANT, 5MM(D) X 15MM(L)	4	NNT513	NANOTITE TAPERED IMPLANT, 5MM(D) X 13MM(L)	7
NINT585	NANOTITE TAPERED CERTAIN IMPLANT, 5MM(D) X 8.5MM(L)	4	NNT515	NANOTITE TAPERED IMPLANT, 5MM(D) X 15MM(L)	7
NINT610	NANOTITE TAPERED CERTAIN IMPLANT, 6MM(D) X 10MM(L)	4	NNT585	NANOTITE TAPERED IMPLANT, 5MM(D) X 8.5MM(L)	7
NINT611	NANOTITE TAPERED CERTAIN IMPLANT, 6MM(D) X 11.5MM(L)	4	NNT610	NANOTITE TAPERED IMPLANT, 6MM(D) X 10MM(L)	7
NINT613	NANOTITE TAPERED CERTAIN IMPLANT, 6MM(D) X 13MM(L)	4	NNT611	NANOTITE TAPERED IMPLANT, 6MM(D) X 11.5MM(L)	7
NINT615	NANOTITE TAPERED CERTAIN IMPLANT, 6MM(D) X 15MM(L)	4	NNT613	NANOTITE TAPERED IMPLANT, 6MM(D) X 13MM(L)	7
NINT685	NANOTITE TAPERED CERTAIN IMPLANT, 6MM(D) X 8.5MM(L)	4	NNT615	NANOTITE TAPERED IMPLANT, 6MM(D) X 15MM(L)	7
NIOSM310	NANOTITE PARALLEL WALLED CERTAIN IMPLANT, 3.25MM(D) X 10MM(L)2		NNT685	NANOTITE TAPERED IMPLANT, 6MM(D) X 8.5MM(L)	7
NIOSM311	NANOTITE PARALLEL WALLED CERTAIN IMPLANT, 3.25MM(D) X 11.5MM(L)2		NOSM310	NANOTITE PARALLEL WALLED IMPLANT, 3.25MM(D) X 10MM(L)	5
NIOSM313	NANOTITE PARALLEL WALLED CERTAIN IMPLANT, 3.25MM(D) X 13MM(L)2		NIOSM311	NANOTITE PARALLEL WALLED IMPLANT, 3.25MM(D) X 11.5MM(L)	5
NIOSM315	NANOTITE PARALLEL WALLED CERTAIN IMPLANT, 3.25MM(D) X 15MM(L)2		NIOSM313	NANOTITE PARALLEL WALLED IMPLANT, 3.25MM(D) X 13MM(L)	5
NIOSM318	NANOTITE PARALLEL WALLED CERTAIN IMPLANT, 3.25MM(D) X 18MM(L)2		NIOSM315	NANOTITE PARALLEL WALLED IMPLANT, 3.25MM(D) X 15MM(L)	5
NIOSM385	NANOTITE PARALLEL WALLED CERTAIN IMPLANT, 3.25MM(D) X 8.5MM(L)2		NIOSM318	NANOTITE PARALLEL WALLED IMPLANT, 3.25MM(D) X 18MM(L)	5
NIOSS410	NANOTITE PARALLEL WALLED CERTAIN IMPLANT, 4MM(D) X 10MM(L)	2	NIOSM385	NANOTITE PARALLEL WALLED IMPLANT, 3.25MM(D) X 8.5MM(L)	5
NIOSS411	NANOTITE PARALLEL WALLED CERTAIN IMPLANT, 4MM(D) X 11.5MM(L)	2	NOSS407	NANOTITE PARALLEL WALLED IMPLANT, 4MM(D) X 7MM(L)	5
NIOSS413	NANOTITE PARALLEL WALLED CERTAIN IMPLANT, 4MM(D) X 13MM(L)	2	NOSS410	NANOTITE PARALLEL WALLED IMPLANT, 4MM(D) X 10MM(L)	5
NIOSS415	NANOTITE PARALLEL WALLED CERTAIN IMPLANT, 4MM(D) X 15MM(L)	2	NOSS411	NANOTITE PARALLEL WALLED IMPLANT, 4MM(D) X 11.5MM(L)	5
NIOSS418	NANOTITE PARALLEL WALLED CERTAIN IMPLANT, 4MM(D) X 18MM(L)	2	NOSS413	NANOTITE PARALLEL WALLED IMPLANT, 4MM(D) X 13MM(L)	5
NIOSS485	NANOTITE PARALLEL WALLED CERTAIN IMPLANT, 4MM(D) X 8.5MM(L)	2	NOSS415	NANOTITE PARALLEL WALLED IMPLANT, 4MM(D) X 15MM(L)	5
NIOSS507	NANOTITE PARALLEL WALLED CERTAIN IMPLANT, 5MM(D) X 7MM(L)	5	NOSS418	NANOTITE PARALLEL WALLED IMPLANT, 4MM(D) X 18MM(L)	5
NIOSS510	NANOTITE PARALLEL WALLED CERTAIN IMPLANT, 5MM(D) X 10MM(L)	5	NOSS485	NANOTITE PARALLEL WALLED IMPLANT, 4MM(D) X 8.5MM(L)	5
NIOSS511	NANOTITE PARALLEL WALLED CERTAIN IMPLANT, 5MM(D) X 11.5MM(L)	5	NOSS507	NANOTITE PARALLEL WALLED IMPLANT, 5MM(D) X 7MM(L)	5
NIOSS513	NANOTITE PARALLEL WALLED CERTAIN IMPLANT, 5MM(D) X 13MM(L)	5	NOSS510	NANOTITE PARALLEL WALLED IMPLANT, 5MM(D) X 10MM(L)	5

Index

Cat.#	Description	Page#	Cat.#	Description	Page#
NOSS515	NANOTITE™ PARALLEL WALLED IMPLANT, 5MM(D) X 15MM(L)	5	NTAP615	DENSE BONE TAP FOR TAPERED IMPLANTS, 6MM(D) X 15MM(L)	28,38
NOSS518	NANOTITE PARALLEL WALLED IMPLANT, 5MM(D) X 18MM(L)	5	NTAP685	DENSE BONE TAP FOR TAPERED IMPLANTS, 6MM(D) X 8.5MM(L)	28,38
NOSS585	NANOTITE PARALLEL WALLED IMPLANT, 5MM(D) X 8.5MM(L)	5	NTAPK	DENSE BONE TAP KIT	38
NOSS607	NANOTITE PARALLEL WALLED IMPLANT, 6MM(D) X 7MM(L)	5	NTDI3210	OSSEOTITE TAPERED DEPTH INDICATOR, 3.25MM X 10MM	29,39
NOSS610	NANOTITE PARALLEL WALLED IMPLANT, 6MM(D) X 10MM(L)	5	NTDI3211	OSSEOTITE TAPERED DEPTH INDICATOR, 3.25MM X 11.5MM	29,39
NOSS611	NANOTITE PARALLEL WALLED IMPLANT, 6MM(D) X 11.5MM(L)	5	NTDI3213	OSSEOTITE TAPERED DEPTH INDICATOR, 3.25MM X 13MM	29,39
NOSS613	NANOTITE PARALLEL WALLED IMPLANT, 6MM(D) X 13MM(L)	5	NTDI3215	OSSEOTITE TAPERED DEPTH INDICATOR, 3.25MM X 15MM	29,39
NOSS615	NANOTITE PARALLEL WALLED IMPLANT, 6MM(D) X 15MM(L)	5	NTDI3285	OSSEOTITE TAPERED DEPTH INDICATOR, 3.25MM X 8.5MM	29,39
NOSS618	NANOTITE PARALLEL WALLED IMPLANT, 6MM(D) X 18MM(L)	5	NTDI410	OSSEOTITE TAPERED DEPTH INDICATOR, 4MM X 10MM	29,39
NOSS685	NANOTITE PARALLEL WALLED IMPLANT, 6MM(D) X 8.5MM(L)	5	NTDI411	OSSEOTITE TAPERED DEPTH INDICATOR, 4MM X 11.5MM	29,39
NT3210	OSSEOTITE® TAPERED IMPLANT, 3.25MM(D) X 10MM(L)	8	NTDI413	OSSEOTITE TAPERED DEPTH INDICATOR, 4MM X 13MM	29,39
NT3211	OSSEOTITE TAPERED IMPLANT, 3.25MM(D) X 11.5MM(L)	8	NTDI415	OSSEOTITE TAPERED DEPTH INDICATOR, 4MM X 15MM	29,39
NT3213	OSSEOTITE TAPERED IMPLANT, 3.25MM(D) X 13MM(L)	8	NTDI485	OSSEOTITE TAPERED DEPTH INDICATOR, 4MM X 8.5MM	29,39
NT3215	OSSEOTITE TAPERED IMPLANT, 3.25MM(D) X 15MM(L)	8	NTDI510	OSSEOTITE TAPERED DEPTH INDICATOR, 5MM X 10MM	29,39
NT3285	OSSEOTITE TAPERED IMPLANT, 3.25MM(D) X 8.5MM(L)	8	NTDI511	OSSEOTITE TAPERED DEPTH INDICATOR, 5MM X 11.5MM	29,39
NT410	OSSEOTITE TAPERED IMPLANT, 4MM(D) X 10MM(L)	8	NTDI513	OSSEOTITE TAPERED DEPTH INDICATOR, 5MM X 13MM	29,39
NT411	OSSEOTITE TAPERED IMPLANT, 4MM(D) X 11.5MM(L)	8	NTDI515	OSSEOTITE TAPERED DEPTH INDICATOR, 5MM X 15MM	29,39
NT413	OSSEOTITE TAPERED IMPLANT, 4MM(D) X 13MM(L)	8	NTDI585	OSSEOTITE TAPERED DEPTH INDICATOR, 5MM X 8.5MM	29,39
NT415	OSSEOTITE TAPERED IMPLANT, 4MM(D) X 15MM(L)	8	NTDI610	OSSEOTITE TAPERED DEPTH INDICATOR, 6MM X 10MM	29,39
NT485	OSSEOTITE TAPERED IMPLANT, 4MM(D) X 8.5MM(L)	8	NTDI611	OSSEOTITE TAPERED DEPTH INDICATOR, 6MM X 11.5MM	29,39
NT510	OSSEOTITE TAPERED IMPLANT, 5MM(D) X 10MM(L)	8	NTDI613	OSSEOTITE TAPERED DEPTH INDICATOR, 6MM X 13MM	29,39
NT511	OSSEOTITE TAPERED IMPLANT, 5MM(D) X 11.5MM(L)	8	NTDI615	OSSEOTITE TAPERED DEPTH INDICATOR, 6MM X 15MM	29,39
NT513	OSSEOTITE TAPERED IMPLANT, 5MM(D) X 13MM(L)	8	NTDI685	OSSEOTITE TAPERED DEPTH INDICATOR, 6MM X 8.5MM	29,39
NT515	OSSEOTITE TAPERED IMPLANT, 5MM(D) X 15MM(L)	8	NTDIK	OSSEOTITE TAPERED DIRECTION/DEPTH INDICATOR KIT	39
NT585	OSSEOTITE TAPERED IMPLANT, 5MM(D) X 8.5MM(L)	8	NTMOD1	3X MODEL OF OSSEOTITE TAPERED IMPLANT	51
NT610	OSSEOTITE TAPERED IMPLANT, 6MM(D) X 10MM(L)	8	NTOST0	OSSEOTITE TAPERED OSTEOTOME SYSTEM KIT, STRAIGHT	45
NT611	OSSEOTITE TAPERED IMPLANT, 6MM(D) X 11.5MM(L)	8	NTOST0A	OSSEOTITE TAPERED OSTEOTOME SYSTEM KIT, ANGLED	45
NT613	OSSEOTITE TAPERED IMPLANT, 6MM(D) X 13MM(L)	8	NTOST3	OSSEOTITE TAPERED STRAIGHT OSTEOTOME, 3.25MM	45
NT615	OSSEOTITE TAPERED IMPLANT, 6MM(D) X 15MM(L)	8	NTOST3A	OSSEOTITE TAPERED ANGLED OSTEOTOME, 3.25MM	45
NT685	OSSEOTITE TAPERED IMPLANT, 6MM(D) X 8.5MM(L)	8	NTOST4	OSSEOTITE TAPERED STRAIGHT OSTEOTOME, 4MM	45
NTAP3210	DENSE BONE TAP FOR TAPERED IMPLANTS, 3.25MM(D) X 10MM(L)	28,38	NTOST4A	OSSEOTITE TAPERED ANGLED OSTEOTOME, 4MM	45
NTAP3211	DENSE BONE TAP FOR TAPERED IMPLANTS, 3.25MM(D) X 11.5MM(L)	28,38	NTOST5	OSSEOTITE TAPERED STRAIGHT OSTEOTOME, 5MM	45
NTAP3213	DENSE BONE TAP FOR TAPERED IMPLANTS, 3.25MM(D) X 13MM(L)	28,38	NTOST5A	OSSEOTITE TAPERED ANGLED OSTEOTOME, 5MM	45
NTAP3215	DENSE BONE TAP FOR TAPERED IMPLANTS, 3.25MM(D) X 15MM(L)	28,38	NTOST6	OSSEOTITE TAPERED STRAIGHT OSTEOTOME, 6MM	45
NTAP3285	DENSE BONE TAP FOR TAPERED IMPLANTS, 3.25MM(D) X 8.5MM(L)	28,38	NTOST6A	OSSEOTITE TAPERED ANGLED OSTEOTOME, 6MM	45
NTAP410	DENSE BONE TAP FOR TAPERED IMPLANTS, 4MM(D) X 10MM(L)	28,38	NTOSTTTRA	OSSEOTITE TAPERED OSTEOTOME TRAY, ANGLED	45
NTAP411	DENSE BONE TAP FOR TAPERED IMPLANTS, 4MM(D) X 11.5MM(L)	28,38	NTOSTTRS	OSSEOTITE TAPERED OSTEOTOME TRAY, STRAIGHT	45
NTAP413	DENSE BONE TAP FOR TAPERED IMPLANTS, 4MM(D) X 13MM(L)	28,38	OG1520	OSSEOGUARD® RESORBABLE COLLAGEN MEMBRANE, 15MM X 20MM	50
NTAP415	DENSE BONE TAP FOR TAPERED IMPLANTS, 4MM(D) X 15MM(L)	28,38	OG2030	OSSEOGUARD RESORBABLE COLLAGEN MEMBRANE, 20MM X 30MM	50
NTAP485	DENSE BONE TAP FOR TAPERED IMPLANTS, 4MM(D) X 8.5MM(L)	28,38	OG3040	OSSEOGUARD RESORBABLE COLLAGEN MEMBRANE, 30MM X 40MM	50
NTAP510	DENSE BONE TAP FOR TAPERED IMPLANTS, 5MM(D) X 10MM(L)	28,38	OS3210	OSSEOTITE XP® PARALLEL WALLED MINIPLANT®, 3.25MM(D) X 4.1MM(P) X 10MM(L)	6
NTAP511	DENSE BONE TAP FOR TAPERED IMPLANTS, 5MM(D) X 11.5MM(L)	28,38	OS3211	OSSEOTITE XP PARALLEL WALLED MINIPLANT, 3.25MM(D) X 4.1MM(P) X 11.5MM(L)	6
NTAP513	DENSE BONE TAP FOR TAPERED IMPLANTS, 5MM(D) X 13MM(L)	28,38	OS3213	OSSEOTITE XP PARALLEL WALLED MINIPLANT, 3.25MM(D) X 4.1MM(P) X 13MM(L)	6
NTAP515	DENSE BONE TAP FOR TAPERED IMPLANTS, 5MM(D) X 15MM(L)	28,38	OS3215	OSSEOTITE XP PARALLEL WALLED MINIPLANT, 3.25MM(D) X 4.1MM(P) X 15MM(L)	6
NTAP585	DENSE BONE TAP FOR TAPERED IMPLANTS, 5MM(D) X 8.5MM(L)	28,38			
NTAP610	DENSE BONE TAP FOR TAPERED IMPLANTS, 6MM(D) X 10MM(L)	28,38			
NTAP611	DENSE BONE TAP FOR TAPERED IMPLANTS, 6MM(D) X 11.5MM(L)	28,38			
NTAP613	DENSE BONE TAP FOR TAPERED IMPLANTS, 6MM(D) X 13MM(L)	28,38			

Index

Cat.#	Description	Page#	Cat.#	Description	Page#
OS3218	OSSEOTITE XP® PARALLEL WALLED MINIPLANT®, 3.25MM(D) X 4.1MM(P) X 18MM(L)	6	OSS585	OSSEOTITE PARALLEL WALLED IMPLANT, 5MM(D) X 8.5MM(L)	6
OS3285	OSSEOTITE XP PARALLEL WALLED MINIPLANT, 3.25MM(D) X 4.1MM(P) X 8.5MM(L)	6	OSS607	OSSEOTITE PARALLEL WALLED IMPLANT, 6MM(D) X 7MM(L)	6
OS4510	OSSEOTITE XP PARALLEL WALLED IMPLANT, 4MM(D) X 5MM(P) X 10MM(L)	6	OSS610	OSSEOTITE PARALLEL WALLED IMPLANT, 6MM(D) X 10MM(L)	6
OS4511	OSSEOTITE XP PARALLEL WALLED IMPLANT, 4MM(D) X 5MM(P) X 11.5MM(L)	6	OSS611	OSSEOTITE PARALLEL WALLED IMPLANT, 6MM(D) X 11.5MM(L)	6
OS4513	OSSEOTITE XP PARALLEL WALLED IMPLANT, 4MM(D) X 5MM(P) X 13MM(L)	6	OSS613	OSSEOTITE PARALLEL WALLED IMPLANT, 6MM(D) X 13MM(L)	6
OS4515	OSSEOTITE XP PARALLEL WALLED IMPLANT, 4MM(D) X 5MM(P) X 15MM(L)	6	OSS615	OSSEOTITE PARALLEL WALLED IMPLANT, 6MM(D) X 15MM(L)	6
OS4585	OSSEOTITE XP PARALLEL WALLED IMPLANT, 4MM(D) X 5MM(P) X 8.5MM(L)	6	OSS618	OSSEOTITE PARALLEL WALLED IMPLANT, 6MM(D) X 18MM(L)	6
OS5610	OSSEOTITE XP PARALLEL WALLED IMPLANT, 5MM(D) X 6MM(P) X 10MM(L)	6	OSS685	OSSEOTITE PARALLEL WALLED IMPLANT, 6MM(D) X 8.5MM(L)	6
OS5611	OSSEOTITE XP PARALLEL WALLED IMPLANT, 5MM(D) X 6MM(P) X 11.5MM(L)	6	OSSMOD1	3X MODEL OF OSSEOTITE IMPLANT, 4MM(D) X 13MM(L)	51
OS5613	OSSEOTITE XP PARALLEL WALLED IMPLANT, 5MM(D) X 6MM(P) X 13MM(L)	6	OST00	SUMMERS OSTEOTOME KIT #1-4	45
OS5615	OSSEOTITE XP PARALLEL WALLED IMPLANT, 5MM(D) X 6MM(P) X 15MM(L)	6	OST01	SUMMERS OSTEOTOME #1	45
OS5685	OSSEOTITE XP PARALLEL WALLED IMPLANT, 5MM(D) X 6MM(P) X 8.5MM(L)	6	OST02	SUMMERS OSTEOTOME #2	45
OSM310	OSSEOTITE® PARALLEL WALLED IMPLANT, 3.25MM(D) X 10MM(L)	6	OST03	SUMMERS OSTEOTOME #3	45
OSM311	OSSEOTITE® PARALLEL WALLED IMPLANT, 3.25MM(D) X 11.5MM(L)	6	OST04	SUMMERS OSTEOTOME #4	45
OSM313	OSSEOTITE PARALLEL WALLED IMPLANT, 3.25MM(D) X 13MM(L)	6	OST05	SUMMERS OSTEOTOME #5	45
OSM315	OSSEOTITE PARALLEL WALLED IMPLANT, 3.25MM(D) X 15MM(L)	6	OST10	SUMMERS OSTEOTOME KIT #1-5	45
OSM318	OSSEOTITE PARALLEL WALLED IMPLANT, 3.25MM(D) X 18MM(L)	6	OST20	SUMMERS OSTEOTOME KIT #1-5 AND FUTURE SITE	45
OSM385	OSSEOTITE PARALLEL WALLED IMPLANT, 3.25MM(D) X 8.5MM(L)	6	OSTFS	SUMMERS OSTEOTOME FOR FUTURE SITE	45
OSS310	OSSEOTITE PARALLEL WALLED IMPLANT, 3.75MM(D) X 10MM(L)	6	OSTTR	SUMMERS OSTEOTOME SYSTEM TRAY	45
OSS311	OSSEOTITE PARALLEL WALLED IMPLANT, 3.75MM(D) X 11.5MM(L)	6	PD100	PILOT REUSABLE DRILL, 2/3MM	31,33,36
OSS313	OSSEOTITE PARALLEL WALLED IMPLANT, 3.75MM(D) X 13MM(L)	6	PEMODLOC	PATIENT ED MODEL - LOCATOR®	51
OSS315	OSSEOTITE PARALLEL WALLED IMPLANT, 3.75MM(D) X 15MM(L)	6	PEMODSM	PATIENT ED MODEL - SINGLE/MULTIPLE TEETH WITH SQUARE SCREW	51
OSS318	OSSEOTITE PARALLEL WALLED IMPLANT, 3.75MM(D) X 18MM(L)	6	PHD00N	NARROW POSTERIOR SMALL HEX DRIVER, 17MM	30,31,33
OSS320	OSSEOTITE PARALLEL WALLED IMPLANT, 3.75MM(D) X 20MM(L)	6	PHD02N	NARROW POSTERIOR LARGE HEX DRIVER, 17MM	26,30,31,33
OSS385	OSSEOTITE PARALLEL WALLED IMPLANT, 3.75MM(D) X 8.5MM(L)	6	PSKT01	STARTER KIT	31,32
OSS410	OSSEOTITE PARALLEL WALLED IMPLANT, 4MM(D) X 10MM(L)	6	PSKT10	BASIC SURGICAL KIT - PLASTIC	33,34
OSS411	OSSEOTITE PARALLEL WALLED IMPLANT, 4MM(D) X 11.5MM(L)	6	PSKT20	STANDARD UNISYSTEM SURGICAL KIT - PLASTIC	33,34
OSS413	OSSEOTITE PARALLEL WALLED IMPLANT, 4MM(D) X 13MM(L)	6	PSKT30	PREMIUM UNISYSTEM SURGICAL KIT	33,34
OSS415	OSSEOTITE PARALLEL WALLED IMPLANT, 4MM(D) X 15MM(L)	6	PSKT30U	CERTAIN® UPGRADE SURGICAL KIT FOR PSKT20/PSKT30	33,34
OSS418	OSSEOTITE PARALLEL WALLED IMPLANT, 4MM(D) X 18MM(L)	6	PSKT35	CERTAIN PREMIUM SURGICAL KIT	31,32
OSS420	OSSEOTITE PARALLEL WALLED IMPLANT, 4MM(D) X 20MM(L)	6	PSKT40	CERTAIN PREMIUM SURGICAL KIT FOR PARALLEL WALLED IMPLANT	31,32
OSS485	OSSEOTITE PARALLEL WALLED IMPLANT, 4MM(D) X 8.5MM(L)	6	PTT100	PLASTIC TRAY ORGANIZER	31,33,34
OSS507	OSSEOTITE PARALLEL WALLED IMPLANT, 5MM(D) X 7MM(L)	6	PTT300I	PLASTIC UNISYSTEM SURGICAL TRAY	31,33
OSS510	OSSEOTITE PARALLEL WALLED IMPLANT, 5MM(D) X 10MM(L)	6	PTT300UI	PLASTIC INSERT FOR TRAY	34
OSS511	OSSEOTITE PARALLEL WALLED IMPLANT, 5MM(D) X 11.5MM(L)	6	QBM001	R. QUÉTIN BONE MILL	50
OSS513	OSSEOTITE PARALLEL WALLED IMPLANT, 5MM(D) X 13MM(L)	6	QNTSK40	TAPERED IMPLANT QUAD SHAPING DRILL, PREMIUM SURGICAL KIT	28,29,30
OSS515	OSSEOTITE PARALLEL WALLED IMPLANT, 5MM(D) X 15MM(L)	6	QNTSK40U	TAPERED IMPLANT QUAD SHAPING DRILL, PREMIUM UPGRADE KIT	28,29,30
OSS518	OSSEOTITE PARALLEL WALLED IMPLANT, 5MM(D) X 18MM(L)	6	QNTSKI	PLASTIC INSERT FOR SURGICAL TRAY	29
			QNTSKT	QSD/NTDI SURGICAL TRAY	29
			QSD3210	QUAD SHAPING DRILL, 3.25MM(D) X 10MM(L)	28,36
			QSD3211	QUAD SHAPING DRILL, 3.25MM(D) X 11.5MM(L)	28,36
			QSD3213	QUAD SHAPING DRILL, 3.25MM(D) X 13MM(L)	28,36
			QSD3215	QUAD SHAPING DRILL, 3.25MM(D) X 15MM(L)	28,36
			QSD3285	QUAD SHAPING DRILL, 3.25MM(D) X 8.5MM(L)	28,36
			QSD410	QUAD SHAPING DRILL, 4MM(D) X 10MM(L)	28,36
			QSD411	QUAD SHAPING DRILL, 4MM(D) X 11.5MM(L)	28,36
			QSD413	QUAD SHAPING DRILL, 4MM(D) X 13MM(L)	28,36
			QSD415	QUAD SHAPING DRILL, 4MM(D) X 15MM(L)	28,36

Index

Cat.#	Description	Page#	Cat.#	Description	Page#
QSD485	QUAD SHAPING DRILL, 4MM(D) X 8.5MM(L)	28,36	SGD385Z	NAVIGATOR TWIST DRILL, 3.85MM(D) X Z(L)	26
QSD510	QUAD SHAPING DRILL, 5MM(D) X 10MM(L)	28,36	SGD3A	NAVIGATOR TWIST DRILL, 3MM(D) X A(L)	25
QSD511	QUAD SHAPING DRILL, 5MM(D) X 11.5MM(L)	28,36	SGD3B	NAVIGATOR TWIST DRILL, 3MM(D) X B(L)	25
QSD513	QUAD SHAPING DRILL, 5MM(D) X 13MM(L)	28,36	SGD3C	NAVIGATOR TWIST DRILL, 3MM(D) X C(L)	25
QSD515	QUAD SHAPING DRILL, 5MM(D) X 15MM(L)	28,36	SGD3D	NAVIGATOR TWIST DRILL, 3MM(D) X D(L)	25
QSD585	QUAD SHAPING DRILL, 5MM(D) X 8.5MM(L)	28,36	SGD3E	NAVIGATOR TWIST DRILL, 3MM(D) X E(L)	25
QSD610	QUAD SHAPING DRILL, 6MM(D) X 10MM(L)	28,36	SGD3Y	NAVIGATOR TWIST DRILL, 3MM(D) X Y(L)	26
QSD611	QUAD SHAPING DRILL, 6MM(D) X 11.5MM(L)	28,36	SGD3Z	NAVIGATOR TWIST DRILL, 3MM(D) X Z(L)	26
QSD613	QUAD SHAPING DRILL, 6MM(D) X 13MM(L)	28,36	SGD425A	NAVIGATOR TWIST DRILL, 4.25MM(D) X A(L)	25
QSD615	QUAD SHAPING DRILL, 6MM(D) X 15MM(L)	28,36	SGD425B	NAVIGATOR TWIST DRILL, 4.25MM(D) X B(L)	26
QSD685	QUAD SHAPING DRILL, 6MM(D) X 8.5MM(L)	28,36	SGD425C	NAVIGATOR TWIST DRILL, 4.25MM(D) X C(L)	26
RASH3N	NARROW RIGHT ANGLE LARGE HEX DRIVER TIP, 24MM	26,30,31,33	SGD425Y	NAVIGATOR TWIST DRILL, 4.25MM(D) X Y(L)	26
RD100	REUSABLE ROUND BUR	31,33,36	SGD425Z	NAVIGATOR TWIST DRILL, 4.25MM(D) X Z(L)	26
RE100	RATCHET EXTENSION SHORT, 6MM(L)	26,29,31,33,44	SGD2E	NAVIGATOR TWIST DRILL, 2MM(D) X E(L)	25
RE200	RATCHET EXTENSION LONG, 15MM(L)	26,29,31,33,44	SGDPH1	NAVIGATOR DRILL POSITIONING HANDLE 1	26
RMB30	RADIOGRAPHIC MARKING BALLS 5MM(D) 30PK	43	SGDPH2	NAVIGATOR DRILL POSITIONING HANDLE 2	26
ROAP05	REGENEROSS® ALLOGRAFT PUTTY, 0.5CC	50	SGDPH3	NAVIGATOR DRILL POSITIONING HANDLE 3	26
ROAP10	REGENEROSS ALLOGRAFT PUTTY, 1.0CC	50	SGDPH4	NAVIGATOR DRILL POSITIONING HANDLE 4	26
ROAP20	REGENEROSS ALLOGRAFT PUTTY, 2.0CC	50	SGDPH5	NAVIGATOR DRILL POSITIONING HANDLE 5	26
ROX05	ENDOBON® XENOGRAFT GRANULES, 0.5ML PACK	50	SGIAM41	NAVIGATOR CERTAIN® ANALOG MOUNT, 4.1MM(D) X 1(L)	27
ROX10	ENDOBON XENOGRAFT GRANULES, 1.0ML PACK	50	SGIAM42	NAVIGATOR CERTAIN ANALOG MOUNT, 4.1MM(D) X 2(L)	27
ROX20	ENDOBON XENOGRAFT GRANULES, 2.0ML PACK	50	SGIAM43	NAVIGATOR CERTAIN ANALOG MOUNT, 4.1MM(D) X 3(L)	27
SEKT1	SINUS ELEVATION KIT	46	SGIAM44	NAVIGATOR CERTAIN ANALOG MOUNT, 4.1MM(D) X 4(L)	27
SEKTR	SINUS ELEVATION TRAY	46	SGIAM51	NAVIGATOR CERTAIN ANALOG MOUNT, 5MM(D) X 1(L)	27
SGD275A	NAVIGATOR® TWIST DRILL 2.75MM(D) X A(L)	23	SGIAM52	NAVIGATOR CERTAIN ANALOG MOUNT, 5MM(D) X 2(L)	27
SGD275B	NAVIGATOR TWIST DRILL, 2.75MM(D) X B(L)	23	SGIAM53	NAVIGATOR CERTAIN ANALOG MOUNT, 5MM(D) X 3(L)	27
SGD275C	NAVIGATOR TWIST DRILL, 2.75MM(D) X C(L)	23	SGIAM54	NAVIGATOR CERTAIN ANALOG MOUNT, 5MM(D) X 4(L)	27
SGD275D	NAVIGATOR TWIST DRILL, 2.75MM(D) X D(L)	23	SGIIM41	NAVIGATOR CERTAIN IMPLANT MOUNT, 4.1MM(D) X 1(L)	26
SGD275E	NAVIGATOR TWIST DRILL, 2.75MM(D) X E(L)	23	SGIIM42	NAVIGATOR CERTAIN IMPLANT MOUNT, 4.1MM(D) X 2(L)	26
SGD275Y	NAVIGATOR TWIST DRILL, 2.75MM(D) X Y(L)	24	SGIIM43	NAVIGATOR CERTAIN IMPLANT MOUNT, 4.1MM(D) X 3(L)	26
SGD275Z	NAVIGATOR TWIST DRILL, 2.75MM(D) X Z(L)	24	SGIIM44	NAVIGATOR CERTAIN IMPLANT MOUNT, 4.1MM(D) X 4(L)	26
SGD2A	NAVIGATOR TWIST DRILL, 2MM(D) X A(L)	25	SGIIM51	NAVIGATOR CERTAIN IMPLANT MOUNT, 5MM(D) X 1(L)	26
SGD2B	NAVIGATOR TWIST DRILL, 2MM(D) X B(L)	25	SGIIM52	NAVIGATOR CERTAIN IMPLANT MOUNT, 5MM(D) X 2(L)	26
SGD2C	NAVIGATOR TWIST DRILL, 2MM(D) X C(L)	25	SGISD5	NAVIGATOR CERTAIN STARTER DRILL, 5MM(D)	25
SGD2D	NAVIGATOR TWIST DRILL, 2MM(D) X D(L)	25	SGKIT	NAVIGATOR SURGICAL KIT	25,26
SGD2Y	NAVIGATOR TWIST DRILL, 2MM(D) X Y(L)	26	SGLKIT	NAVIGATOR LABORATORY KIT	27
SGD2Z	NAVIGATOR TWIST DRILL, 2MM(D) X Z(L)	26	SGLTRAY	NAVIGATOR LABORATORY TRAY	27
SGD325A	NAVIGATOR TWIST DRILL, 3.25MM(D) X A(L)	25	SGM-E20RI	20:1 HANDPIECE	22
SGD325B	NAVIGATOR TWIST DRILL, 3.25MM(D) X B(L)	25	SGSD34	NAVIGATOR STARTER DRILL, 3/4MM(D)	25
SGD325C	NAVIGATOR TWIST DRILL, 3.25MM(D) X C(L)	25	SGSD4	NAVIGATOR STARTER DRILL, 4.1MM(D)	25
SGD325D	NAVIGATOR TWIST DRILL, 3.25MM(D) X D(L)	25	SGSD45	NAVIGATOR STARTER DRILL, 4/5MM(D)	25
SGD325E	NAVIGATOR TWIST DRILL, 3.25MM(D) X E(L)	25	SGT25	STENT GUIDE TUBE (25PK)	44
SGD325Y	NAVIGATOR TWIST DRILL, 3.25MM(D) X Y(L)	26	SGTAP4	NAVIGATOR BONE TAP, 4.1MM(D)	26
SGD325Z	NAVIGATOR TWIST DRILL, 3.25MM(D) X Z(L)	26	SGTAP45	NAVIGATOR BONE TAP, 4/5MM(D)	26
SGD385A	NAVIGATOR TWIST DRILL, 3.85MM(D) X A(L)	25	SGTAP5	NAVIGATOR BONE TAP, 5MM(D)	26
SGD385B	NAVIGATOR TWIST DRILL, 3.85MM(D) X B(L)	25	SGTP4	NAVIGATOR TISSUE PUNCH, 4.1MM(D)	25
SGD385C	NAVIGATOR TWIST DRILL, 3.85MM(D) X C(L)	25	SGTP5	NAVIGATOR TISSUE PUNCH, 5MM(D)	25
SGD385Y	NAVIGATOR TWIST DRILL, 3.85MM(D) X Y(L)	26	SGTRAY	NAVIGATOR SURGICAL TRAY	25

Index

Cat.#	Description	Page#	Cat.#	Description	Page#
TAP10	BONE TAP, 3.75MM(D) X 7-10MM(L)	38	TIPS1	SMALL TITANIUM PLUGGER	46
TAP13	BONE TAP, 3.75MM(D) X 7-13MM(L)	38	TMP80	TISSUE MEASURING POST	43
TAP20	BONE TAP, 3.75MM(D) X 7-20MM(L)	38	TP001	TISSUE PUNCH, 4.1MM(D)	44
TAP410	BONE TAP, 4MM(D) X 7-10MM(L)	38	TP005	TISSUE PUNCH, 5MM(D)	44
TAP413	BONE TAP, 4MM(D) X 7-13MM(L)	31,33,38	TP006	TISSUE PUNCH, 6MM(D)	44
TAP420	BONE TAP, 4MM(D) X 7-20MM(L)	38	TRE02	TREPHINE BUR - 2MM INSIDE DIAMETER/3MM OUTSIDE DIAMETER	46
TAP518S	BONE TAP, 5MM(D) X 7-18MM(L)	38	TRE04	TREPHINE BUR - 4MM INSIDE DIAMETER/5MM OUTSIDE DIAMETER	46
TAP53S	BONE TAP, 5MM(D) X 7-13MM(L)	32,34,38	TRE05	TREPHINE BUR - 5MM INSIDE DIAMETER/6MM OUTSIDE DIAMETER	46
TAP58S	BONE TAP, 5MM(D) X 7-8.5MM(L)	38	TRE06	TREPHINE BUR - 6MM INSIDE DIAMETER/7MM OUTSIDE DIAMETER	46
TAP618S	BONE TAP, 6MM(D) X 7-18MM(L)	38	TRE08	TREPHINE BUR - 8MM INSIDE DIAMETER/9.3MM OUTSIDE DIAMETER	46
TAP63S	BONE TAP, 6MM(D) X 7-13MM(L)	32,34,38	TST01	TITANIUM SUCTION TIP	42
TAP68S	BONE TAP, 6MM(D) X 7-8.5MM(L)	38	U166-013	ELECTRICAL POWER CORD, 120V	22
TE003	TITANIUM ELEVATOR	42	U198-013	ELECTRICAL POWER CORD, 230V AUSTRALIA	22
TF002	TITANIUM FORCEPS	42	U260-414	ELECTRICAL POWER CORD, 230V EUROPE	22
TH253	2-PC EP® HEALING ABUTMENT, 4.1MM(D) X 5MM(P) X 3MM(H)	17	U195-152	FUSES (100V/120V)	22
TH254	2-PC EP HEALING ABUTMENT, 4.1MM(D) X 5MM(P) X 4MM(H)	17	U197-152	FUSES (230V)	22
TH256	2-PC EP HEALING ABUTMENT, 4.1MM(D) X 5MM(P) X 6MM(H)	17	U370-152	COOLANT SOLUTION HANGAR POST	22
TH258	2-PC EP HEALING ABUTMENT, 4.1MM(D) X 5MM(P) X 8MM(H)	17	U370-003	CONTROL UNIT, 100V	22
TH263	2-PC EP HEALING ABUTMENT, 4.1MM(D) X 6MM(P) X 3MM(H)	17	U371-003	CONTROL UNIT, 120V	22
TH264	2-PC EP HEALING ABUTMENT, 4.1MM(D) X 6MM(P) X 4MM(H)	17	U372-003	CONTROL UNIT, 230V	22
TH266	2-PC EP HEALING ABUTMENT, 4.1MM(D) X 6MM(P) X 6MM(H)	17	U389-013	ELECTRICAL POWER CORD, 100V	22
TH268	2-PC EP HEALING ABUTMENT, 4.1MM(D) X 6MM(P) X 8MM(H)	17	WR150	RATCHET WRENCH	29,31,33,42
TH273	2-PC EP HEALING ABUTMENT, 4.1MM(D) X 7.5MM(P) X 3MM(H)	17	WT2553	2-PC EP HEALING ABUTMENT, 5MM(D) X 5MM(P) X 3MM(H)	18
TH274	2-PC EP HEALING ABUTMENT, 4.1MM(D) X 7.5MM(P) X 4MM(H)	17	WT2554	2-PC EP HEALING ABUTMENT, 5MM(D) X 5MM(P) X 4MM(H)	18
TH276	2-PC EP HEALING ABUTMENT, 4.1MM(D) X 7.5MM(P) X 6MM(H)	17	WT2556	2-PC EP HEALING ABUTMENT, 5MM(D) X 5MM(P) X 6MM(H)	18
TH278	2-PC EP HEALING ABUTMENT, 4.1MM(D) X 7.5MM(P) X 8MM(H)	17	WT2558	2-PC EP HEALING ABUTMENT, 5MM(D) X 5MM(P) X 8MM(H)	18
THA42	EP HEALING ABUTMENT, 4.1MM(D) X 4.1MM(P) X 2MM(H)	15	WT2563	2-PC EP HEALING ABUTMENT, 5MM(D) X 6MM(P) X 3MM(H)	18
THA43	EP HEALING ABUTMENT, 4.1MM(D) X 4.1MM(P) X 3MM(H)	15	WT2564	2-PC EP HEALING ABUTMENT, 5MM(D) X 6MM(P) X 4MM(H)	18
THA44	EP HEALING ABUTMENT, 4.1MM(D) X 4.1MM(P) X 4MM(H)	15	WT2566	2-PC EP HEALING ABUTMENT, 5MM(D) X 6MM(P) X 6MM(H)	18
THA46	EP HEALING ABUTMENT, 4.1MM(D) X 4.1MM(P) X 6MM(H)	15	WT2568	2-PC EP HEALING ABUTMENT, 5MM(D) X 6MM(P) X 8MM(H)	18
THA48	EP HEALING ABUTMENT, 4.1MM(D) X 4.1MM(P) X 8MM(H)	15	WT2573	2-PC EP HEALING ABUTMENT, 5MM(D) X 7.5MM(P) X 3MM(H)	18
THA52	EP HEALING ABUTMENT, 4.1MM(D) X 5MM(P) X 2MM(H)	15	WT2574	2-PC EP HEALING ABUTMENT, 5MM(D) X 7.5MM(P) X 4MM(H)	18
THA53	EP HEALING ABUTMENT, 4.1MM(D) X 5MM(P) X 3MM(H)	15	WT2576	2-PC EP HEALING ABUTMENT, 5MM(D) X 7.5MM(P) X 6MM(H)	18
THA54	EP HEALING ABUTMENT, 4.1MM(D) X 5MM(P) X 4MM(H)	15	WT2578	2-PC EP HEALING ABUTMENT, 5MM(D) X 7.5MM(P) X 8MM(H)	18
THA56	EP HEALING ABUTMENT, 4.1MM(D) X 5MM(P) X 6MM(H)	15	WT2663	2-PC EP HEALING ABUTMENT, 6MM(D) X 6MM(P) X 3MM(H)	18
THA58	EP HEALING ABUTMENT, 4.1MM(D) X 5MM(P) X 8MM(H)	15	WT2664	2-PC EP HEALING ABUTMENT, 6MM(D) X 6MM(P) X 4MM(H)	18
THA63	EP HEALING ABUTMENT, 4.1MM(D) X 6MM(P) X 3MM(H)	15	WT2666	2-PC EP HEALING ABUTMENT, 6MM(D) X 6MM(P) X 6MM(H)	18
THA64	EP HEALING ABUTMENT, 4.1MM(D) X 6MM(P) X 4MM(H)	15	WT2668	2-PC EP HEALING ABUTMENT, 6MM(D) X 6MM(P) X 8MM(H)	18
THA66	EP HEALING ABUTMENT, 4.1MM(D) X 6MM(P) X 6MM(H)	15	WT2673	2-PC EP HEALING ABUTMENT, 6MM(D) X 7.5MM(P) X 3MM(H)	18
THA68	EP HEALING ABUTMENT, 4.1MM(D) X 6MM(P) X 8MM(H)	15	WT2674	2-PC EP HEALING ABUTMENT, 6MM(D) X 7.5MM(P) X 4MM(H)	18
THA73	EP HEALING ABUTMENT, 4.1MM(D) X 7.5MM(P) X 3MM(H)	15	WT2676	2-PC EP HEALING ABUTMENT, 6MM(D) X 7.5MM(P) X 6MM(H)	18
THA74	EP HEALING ABUTMENT, 4.1MM(D) X 7.5MM(P) X 4MM(H)	15	WT2678	2-PC EP HEALING ABUTMENT, 6MM(D) X 7.5MM(P) X 8MM(H)	18
THA76	EP HEALING ABUTMENT, 4.1MM(D) X 7.5MM(P) X 6MM(H)	15	WTH52	HEALING ABUTMENT, 5MM(D) X 5MM(P) X 2MM(H)	16
THA78	EP HEALING ABUTMENT, 4.1MM(D) X 7.5MM(P) X 8MM(H)	15	WTH53	HEALING ABUTMENT, 5MM(D) X 5MM(P) X 3MM(H)	16
THRC4	TEMPORARY HEALING RETENTION CYLINDER, 4.1MM(D) X 4MM(H)	15	WTH54	HEALING ABUTMENT, 5MM(D) X 5MM(P) X 4MM(H)	16
THRC6	TEMPORARY HEALING RETENTION CYLINDER, 4.1MM(D) X 6MM(H)	15	WTH56	HEALING ABUTMENT, 5MM(D) X 5MM(P) X 6MM(H)	16
TIBC1	TITANIUM NITRIDE COATED BONE CARRIER FOR SEKT1	46	WTH562	EP HEALING ABUTMENT, 5MM(D) X 6MM(P) X 2MM(H)	16
TIPL1	LARGE TITANIUM PLUGGER	46	WTH563	EP HEALING ABUTMENT, 5MM(D) X 6MM(P) X 3MM(H)	16

Index

Cat. #	Description	Page#	Cat. #	Description	Page#
WTH564	EP HEALING ABUTMENT, 5MM(D) X 6MM(P) X 4MM(H)	16			
WTH566	EP HEALING ABUTMENT, 5MM(D) X 6MM(P) X 6MM(H)	16			
WTH568	EP HEALING ABUTMENT, 5MM(D) X 6MM(P) X 8MM(H)	16			
WTH572	EP HEALING ABUTMENT, 5MM(D) X 7.5MM(P) X 2MM(H)	16			
WTH573	EP HEALING ABUTMENT, 5MM(D) X 7.5MM(P) X 3MM(H)	16			
WTH574	EP HEALING ABUTMENT, 5MM(D) X 7.5MM(P) X 4MM(H)	16			
WTH576	EP HEALING ABUTMENT, 5MM(D) X 7.5MM(P) X 6MM(H)	16			
WTH578	EP HEALING ABUTMENT, 5MM(D) X 7.5MM(P) X 8MM(H)	16			
WTH58	HEALING ABUTMENT, 5MM(D) X 5MM(P) X 8MM(H)	16			
WTH62	HEALING ABUTMENT, 6MM(D) X 6MM(P) X 2MM(H)	16			
WTH63	HEALING ABUTMENT, 6MM(D) X 6MM(P) X 3MM(H)	16			
WTH64	HEALING ABUTMENT, 6MM(D) X 6MM(P) X 4MM(H)	16			
WTH66	HEALING ABUTMENT, 6MM(D) X 6MM(P) X 6MM(H)	16			
WTH672	EP HEALING ABUTMENT, 6MM(D) X 7.5MM(P) X 2MM(H)	16			
WTH673	EP HEALING ABUTMENT, 6MM(D) X 7.5MM(P) X 3MM(H)	16			
WTH674	EP HEALING ABUTMENT, 6MM(D) X 7.5MM(P) X 4MM(H)	16			
WTH676	EP HEALING ABUTMENT, 6MM(D) X 7.5MM(P) X 6MM(H)	16			
WTH678	EP HEALING ABUTMENT, 6MM(D) X 7.5MM(P) X 8MM(H)	16			
WTH68	EP HEALING ABUTMENT, 6MM(D) X 6MM(P) X 8MM(H)	16			
XDG00	GELB X-RAY DEPTH GAUGE KIT	44			
XDG01	GELB X-RAY DEPTH GAUGE KIT, 2.3MM(D)	44			
XDG13	GELB X-RAY DEPTH GAUGE, 2MM(D) X 13MM(L)	44			
XDG20	GELB X-RAY DEPTH GAUGE, 2MM(D) X 20MM(L)	44			
XDG2313	GELB X-RAY DEPTH GAUGE, 2.3MM(D) X 13MM(L)	44			
XDG2320	GELB X-RAY DEPTH GAUGE, 2.3MM(D) X 20MM(L)	44			
Y900-083	TUBE HOLDER	22			
Y900-114	IRRIGATION TUBES, DISPOSABLE (10/PACK)	22			
Z095-102	MOTOR CRADLE	22			
Z103-101	HANDPIECE WRENCH	22			
Z114-090	SPRAY LUBRICANT NOZZLE	22			
Z144-095	NOZZLE CLEANING FINE WIRE	22			
Z272-004	FOOT CONTROL (3.5M)	22			

Ordering Information

Some products may not be available outside the U.S.A.
Algunos productos no se comercializan fuera de EE.UU.
Certains produits ne sont pas disponibles en dehors des États-Unis.
Einige Produkte sind außerhalb der USA nicht erhältlich.

To Place an Order:

Contact your local BIOMET **3i**, Inc. Representative or call:
BIOMET **3i**, Inc. Customer Service
Monday–Thursday 8am–8pm (EST)
Friday 8am–6:30pm (EST)
800-342-5454 Fax 561-776-1272
In Canada: 800-363-1980 Outside US: 561-776-6700

TERMS AND CONDITIONS OF SALE. The following are the terms and conditions by which BIOMET **3i**, Inc. sells its products.

GOVERNING TERMS. Any shipment of products shall be deemed to be on the terms and conditions stated herein. Any and all terms and conditions submitted by Purchaser are hereby rejected.

TAXES. The prices set forth herein do not include any sales, use, excise, ad valorem, property or other taxes applicable to the sale, use or delivery of the products, all of which shall be paid by Purchaser separately or added to the contract price and paid by Purchaser to BIOMET **3i**, Inc.

PRICES. The prices set forth for the products are in United States Dollars.

DELIVERY. Products sold hereunder shall be delivered F.O.B. manufacturer's plant or distributor's plant, as applicable. Purchaser shall assume responsibility for all subsequent delivery or shipping charges.

PAYMENT. Payment terms shall be as set forth under the "Terms" section on front of invoice.

WARRANTY. EXCEPT AS EXPRESSLY SET FORTH IN THE "BIOMET **3i**, INC. FIVE YEAR WARRANTY PROGRAM," NEITHER BIOMET **3i**, INC. NOR ANY OF ITS AFFILIATES MAKE ANY WARRANTY, EXPRESS OR IMPLIED, EXCEPT THAT ITS PRODUCTS SHALL BE FREE FROM DEFECTS IN MATERIAL AND/OR WORKMANSHIP. THIS WARRANTY APPLIES ONLY TO THE ORIGINAL PURCHASER. IN THE EVENT OF A PRODUCT DEFECT, IMMEDIATELY NOTIFY BIOMET **3i**, INC. OF THE DEFECT PRIOR TO RETURNING THE PRODUCT. DEVICES SHALL BE STERILIZED PRIOR TO RETURN. AS ITS SOLE OBLIGATION AND AS PURCHASER'S SOLE REMEDY UNDER THIS WARRANTY, BIOMET **3i**, INC. WILL, AT ITS OPTION, EITHER REPAIR, REPLACE OR ISSUE CREDIT FOR SUCH PRODUCTS. PURCHASER ASSUMES ALL RISKS AND LIABILITY RESULTING FROM THE USE OF THESE PRODUCTS, WHETHER USED SEPARATELY OR IN COMBINATION WITH OTHER PRODUCTS.

EXCEPT FOR THE WARRANTY EXPRESSLY DESCRIBED IN "WARRANTY" PARAGRAPH ABOVE, NEITHER BIOMET **3i**, INC. NOR ANY OF ITS AFFILIATES MAKES ANY OTHER WARRANTY WITH RESPECT TO THE BIOMET **3i**, INC. PRODUCTS, EXPRESSED OR IMPLIED, WRITTEN OR ORAL, INCLUDING, WITHOUT LIMITATION, ANY IMPLIED WARRANTY OF MERCHANTABILITY, OR A WARRANTY OF FITNESS FOR A PARTICULAR PURPOSE.

EDUCATION; MODIFICATION OF PRODUCTS. BIOMET **3i**, Inc. strongly recommends completion of formal post graduate implant education and strict adherence to the procedures described in BIOMET **3i**, Inc.'s Implant Instruction Manuals. BIOMET **3i**, Inc. continually strives to improve its products and therefore reserves the right to improve, modify or discontinue products at any time, or to change specifications of the products without notice and without incurring any obligation.

RETURN POLICY. A Purchaser may return any BIOMET **3i**, Inc. Product within 90 days of the invoice date. BIOMET **3i**, Inc. Products returned within 60 days of the invoice date will be accepted without any re-stocking fee to the Purchaser. BIOMET **3i**, Inc. Products returned between 61 and 90 days of the invoice date will be subject to a 15% restocking fee. A BIOMET **3i**, Inc. Product will be accepted for return only if the BIOMET **3i**, Inc. Product is (1) returned in its original, unopened package (including autoclavable products); (2) received by BIOMET **3i**, Inc. within 90 days after the invoice date for that product; and (3) returned freight prepaid to 4555 Riverside Drive, Palm Beach Gardens, Florida 33410, (Attention: Returns Department) accompanied by the BIOMET **3i**, Inc. Return authorization number provided by BIOMET **3i**, Inc.'s Customer Service Department. Purchaser should be advised that BIOMET **3i**, Inc. Products not meeting the above criteria will not be accepted for return.

EXCHANGE POLICY. BIOMET **3i**, Inc. Products may be exchanged within 180 days of the invoice date, without a re-stocking fee, for other BIOMET **3i**, Inc. Products of equal or lesser value within the same product family as determined by

BIOMET **3i**, Inc. (ex. implant for implant, abutment for abutment, membrane for membrane). BIOMET **3i**, Inc. Products may be exchanged within 180 days of the invoice date for other BIOMET **3i**, Inc. Products of greater value within the same product family as determined by BIOMET **3i**, Inc. (ex. implant for implant, abutment for abutment, membrane for membrane), with the price differential paid by the Purchaser. In both cases, the exchanged BIOMET **3i**, Inc. Product must be (1) returned in its original, unopened package (including autoclavable products); (2) a currently offered BIOMET **3i**, Inc. Product (discontinued product not included); and (3) returned freight prepaid to 4555 Riverside Drive, Palm Beach Gardens, Florida 33410, (Attention: Returns Department) and accompanied by the BIOMET **3i**, Inc. Return Authorization Number provided by BIOMET **3i**, Inc.'s Customer Service Department.

LICENSES, PERMITS AND EXPORT CONTROL. The timely securing of permits, licenses or other local, state or federal governmental approvals required in connection with Purchaser's use of any products hereunder shall be the sole responsibility of Purchaser and Purchaser shall bear the cost thereof. Unless otherwise agreed between BIOMET **3i**, Inc. and Purchaser, products sold hereunder are only for use in the United States. Purchaser agrees that the Purchaser will comply fully with all applicable state and federal laws and regulations and Purchaser shall indemnify BIOMET **3i**, Inc. for all losses, damages and penalties incurred as a result of any violation of applicable state or federal law or regulations.

The advertised devices may not have been licensed in accordance with Canadian Law.

FORCE MAJEURE. BIOMET **3i**, Inc. shall not be liable for any loss or damage due to failure or delay arising out of any cause beyond the reasonable control of BIOMET **3i**, Inc. In the event of any failure or delay resulting from such causes, an equitable adjustment of delivery and any other appropriate terms and conditions shall be made. No such failure or delay shall be the basis for an increase in BIOMET **3i**, Inc.'s obligations nor any termination by Purchaser.

LIMITATION OF LIABILITY. UNDER NO CIRCUMSTANCES SHALL BIOMET **3i**, INC. OR ANY OF ITS AFFILIATES BE LIABLE FOR BUSINESS INTERRUPTION, LOSS OF PROFITS, SPECIAL, INDIRECT, INCIDENTAL OR CONSEQUENTIAL DAMAGES OF ANY NATURE AND FROM ANY CAUSE WHETHER BASED IN CONTRACT, WARRANTY OR TORT (INCLUDING NEGLIGENCE) OR OTHER LEGAL THEORY, EVEN IF BIOMET **3i**, INC. HAS BEEN ADVISED OF THE POSSIBILITY OF SUCH DAMAGES.

VALIDITY. If any provision of these Terms and Conditions is found to be illegal or unenforceable in any respect, such illegality or unenforceability shall not affect any other provision of these Terms and Conditions, all of which shall remain enforceable in accordance with their terms.

GENERAL PROVISIONS. The purchase of the products and these Terms and Conditions are governed by the laws of Florida, without regard to conflicts of law principles. This document incorporates all oral and written representations between the parties and constitutes the entire agreement and understanding of the parties with respect to the subject matter hereof and supercedes any and all other agreements either oral or written between the parties with respect to such subject matter. No amendment or modification may be made to this document unless in writing and duly executed by an authorized representative of BIOMET **3i**, Inc.

CAUTION. Federal (U.S.) Law restricts these devices to sale by or on the order of a licensed healthcare practitioner. Devices labeled "STERILE" are certified to be sterile unless sterile package is opened or damaged.

EXPORT ORDERS. Require advance payment or letter of credit. Shipments are made either freight collect or paid by BIOMET **3i**, Inc. and added to invoice. Unless special instructions are received with the order, the shipping method will be determined by BIOMET **3i**, Inc., F.O.B. Palm Beach Gardens, FL.

TRADEMARKS. BIOMET **3i** LLC. Registered Trademarks®: BIOMET **3i** and design, ACT, Advanced Cutting Technology, ARCHITECH PSR, Biogran, CAM StructSURE, Certain, DIEM, Encode, EP, GingiHue, Gold-Tite, IOL, Miniplant, Navigator, OSSEOCISION, OsseoGuard, OSSEOTITE, OSSEOTITE XP, PreFormance, Prep-Tite, PREVAIL, Provide, QuickBridge, QuickSeat, RegenerOss, STA and ZIReal are registered trademarks of BIOMET **3i** LLC.

BIOMET **3i** LLC. Trademarks™: BIOMET **3i**, BIOMET **3i** IDS, Gold Standard ZR, ICE, NanoTite, Providing Solutions – One Patient At A Time and Twist Lock are trademarks of BIOMET **3i** LLC.

Biomet is a registered trademark of BIOMET, Inc. Calcigen is a trademark of BIOMET, Inc. Dolder is a registered trademark of Prof. Eugen Dolder, formerly the director of the School of Dentistry at the University of Zurich. Endobon is a registered trademark of BIOMET Deutschland GmbH. LOCATOR is a registered trademark of Zest Anchors, Inc. Safescraper is a registered trademark of CGM S.p.A. Divisione Medica META.

SUBSIDIARIES

AUSTRALIA

Phone: +61-2-9855-4444
Fax: +61-2-9888-9900

AUSTRIA

Phone: +43-(0)6235-200-45
Fax: +43-(0)6235-200-45-9

BELGIUM

Phone: +32-2-5410290
Fax: +32-2-5410291

BRAZIL

Phone: +55-11-5081-4405
Fax: +55-11-5081-7484

CANADA

Phone: +514-956-9843
Fax: +514-956-9844

FRANCE

Phone: +33-1-41054343
Fax: +33-1-41054340

GERMANY

Phone: +49-721-255177-10
Fax: +49-721-255177-73

IRELAND

Phone: +353-1-800-552-752
Fax: +44-1628-820182

JAPAN

Phone: +81-66868-3012
Fax: +81-66868-2444

KOREA

Phone: +82-2-5678-550
Fax: +82-2-5678-577

MEXICO

Phone: +52-55-2282-0120
Fax: +52-55-2282-0120 ext. 20

THE NETHERLANDS

Phone: +31-(0)78-629-2800
Fax: +31-(0)78-629-2801

NEW ZEALAND

Phone: +64-508-122-221
Fax: +64-508-133-331

NORDIC REGION

Phone: +46-40-17-6090
Fax: +46-40-17-6099

PORTUGAL

Phone: +34-902-34-34-31
Fax: +34-93-445-81-36
+351-21-000-16-75

SPAIN

Phone: +34-902-34-34-31
Fax: +34-93-445-81-36

SWITZERLAND

Phone: +41-(0)44-200-76-00
Fax: +41-(0)44-200-76-01

U.K.

Phone: +44-800-652-1233
Fax: +44-1628-820182

DISTRIBUTORS

ARGENTINA

Dentalmax, SA
Phone: +54-1-1482-71001
Fax: +54-1-1482-67373

CHILE

Cybel, SA
Phone: +56-2-2321883
Fax: +56-2-2330176

CHINA

Atek Inc.
Phone: +86-21-6329-1265
Fax: +86-21-6329-1620

COLOMBIA

3i Colombia
Phone: +571-612-9362
Fax: +571-620-6412

COSTA RICA

Implantec S.A.
Phone: +506-234-9043
Fax: +506-224-7620

EL SALVADOR

Dentimero SA de CV
Phone: +503-263-6350
Fax: +503-263-6676

GREECE

Impladend Dental Implants, LLC
Phone: +30-2310-501-651
Fax: +30-2310-862-090

ISRAEL

H.A. Systems
Phone: +972-3-6138777
Fax: +972-3-6138778

HONG KONG

Ositek Inc., Ltd.
Phone: +852-8121-6601
Fax: +852-3747-3754

ITALY

Biomax spa
Phone: +39-0444-913410
Fax: +39-0444-913695

MIDDLE EAST

3i MENA s.a.l.
Middle East And North Africa
Phone: +961-1-694000
Fax: +961-1-694222

PARAGUAY

Andres H. Arce y Cia SRL
Phone: +595-21-208185
Fax: +595-21-496291

POLAND

Dental Depot Wasio
Phone: +48 71 335 70 71
Fax: +48 71 335 70 90

RUSSIA

Com-Dental
Phone: +7-495-580-3080
Fax: +7-495-580-3081

SINGAPORE

Asia Implant Support & Services
Phone: +65-6223-2229
Fax: +65-6220-3538

SOUTH AFRICA

Selective Aesthetics
Phone: +27-11-991-7068
Fax: +27-11-672-1391

TAIWAN

Kuo Hwa Dental Suppliers Co., Ltd.
Phone: +886-2-2226-1770
Fax: +886-2-2226-8747

THAILAND

3i (Thailand) Co., LTD.
Phone: +662-252-6685
Fax: +662-252-6686

TURKEY

Tamer Med. A.Ş.-Turkey
Phone: +90-212-465-3352
Fax: +90-212-465-3502

UKRAINE

Victoria Premium
Phone: +38-044-331-10-09
Fax: +38-044-331-10-70

URUGUAY

Pro3implant S.R.L.
Phone: +598-2-4034163
Fax: +598-2-4034163

VIETNAM

D.O.E.
(Dentistry Of Excellence Vietnam)
Phone: +84 89 25 37 03
Fax: +84 89 25 37 00



CATSUR
REV B 11/10

Some products may not be available in all markets. Please contact your local BIOMET 3i Sales Representative for availability.

To Receive Information About 's Products, Services And Events By Email, Please Visit Our Website At www.biomet3i.com

BIOMET 3i

4555 Riverside Drive
Palm Beach Gardens, FL 33410
1-800-342-5454
Outside The U.S.: +1-561-776-6700
Fax: +1-561-776-1272
www.biomet3i.com



BIOMET 3i Dental Iberica, S.L.
WTC Almeda Park, Ed. 1, Planta 1ª
Pl. de la Pau s/n
08940 – Cornellà de Llobregat
(Barcelona) Spain
Phone: +34-934-705-500
Fax: +34-933-717-849

BIOMET 3i™
PROVIDING SOLUTIONS – ONE PATIENT AT A TIME™